



better together

50Hz

Серия **Grey**

DGG
DRG
GRG
APG

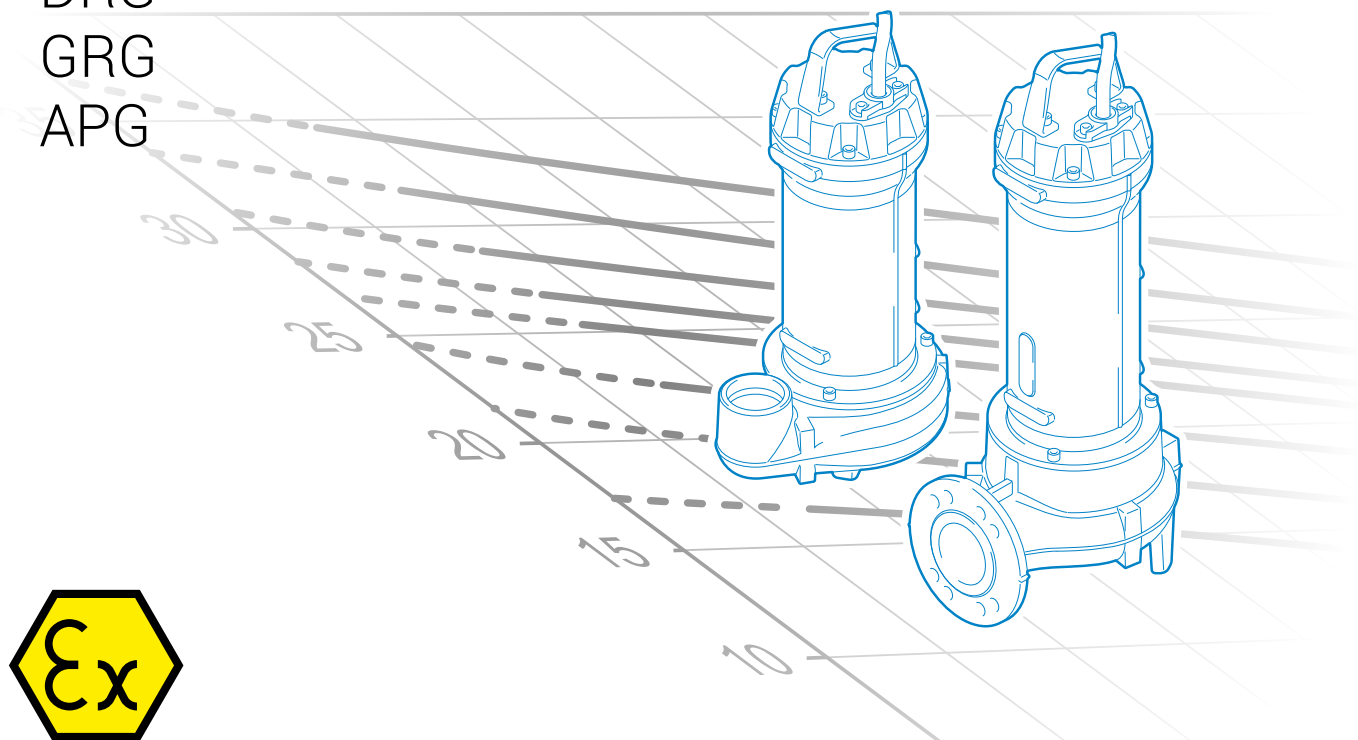

D A T A B O O K L E T

zenit.com

RU



better together

Серия **Grey**

DGG

DRG

GRG

APG



D A T A B O O K L E T

Серия Grey

Общие характеристики

Двигатель

- Чугунная конструкция
- Два механических уплотнения из карбида кремния (2SiC), оба устанавливаемых в камере с маслом
- Датчик обнаружения протечек
- Экологический сухой двигатель с тепловой защитой.
- Защищенные, самосмазывающиеся подшипники со смазкой без замены.



Гидравлические серии



DG (Draga)

p. 9

- погружные электронасосы с многоканальной открытой крыльчаткой
- Находит применение при наличии биологических загрязненных жидкостей и канализационных неотфильтрованных стоков, а также для подъема гражданских стоков. Отлично подходит для использования в очистных сооружениях, канализационных системах, животноводческих фермах, в промышленности и сельском хозяйстве.



DR (Dreno)

p. 23

- погружные электронасосы с многоканальной открытой крыльчаткой
- Разработан в основном для профессионального и промышленного использования, такого как очистка вод, канализационные системы и животноводческие фермы. Особенно пригоден для обработки жидкостей, содержащих твердые взвешенные тела, активный шлам с низкой или средней плотностью.



GR (Grinder)

p. 55

- погружные электронасосы электронасосы
- Разработанный для промышленного и профессионального применения, он пригоден для обработки жидкостей, содержащих твердые тела или волокна во взвешенном состоянии, активный шлам низкой или средней вязкости.



AP (Alta Prevalenza)

p. 59

- погружные электронасосы с крыльчаткой высокого напора
- Рекомендуется для чистой, атмосферной воды, дренажной воды. Значительный манометрический напор обеспечивает отличные результаты при устройстве водных игр и декоративных фонтанов, пригоден для использования в сельском хозяйстве, поливе и рыбоводстве.

Сферы применения

DGG

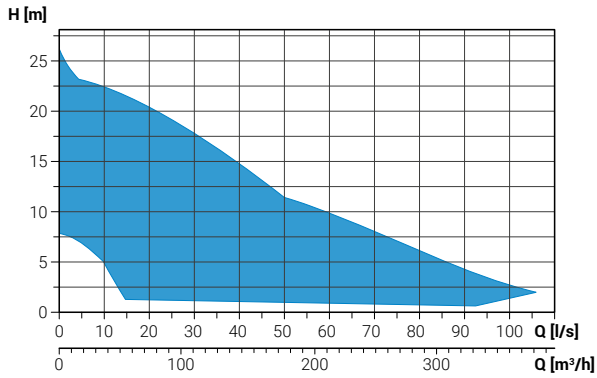

DRG

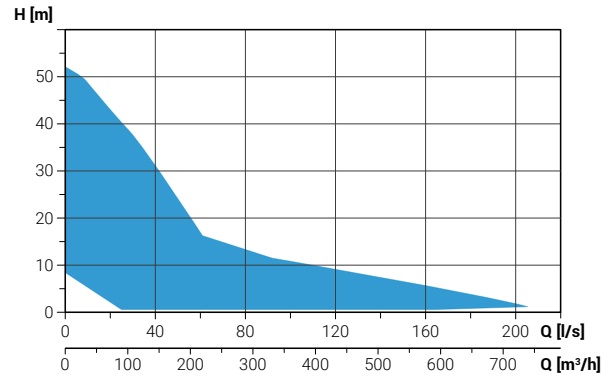

GRG

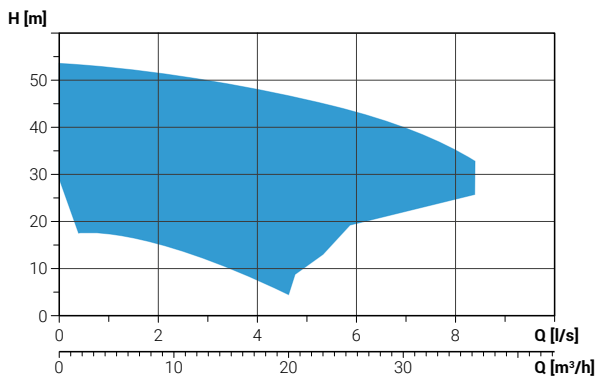

APG

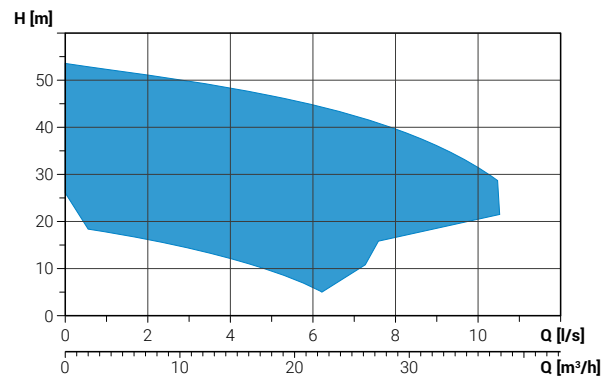

Доступные версии

Электрические варианты

- NAE** Установленные электрические аксессуары отсутствуют
- TS** Тепловая защита, датчик

Система охлаждения

- N** Отсутствие систем охлаждения и/или промывки уплотнений

Трехфазные модели

- 2SiC** 2 механических уплотнения из карбида кремния

Установка

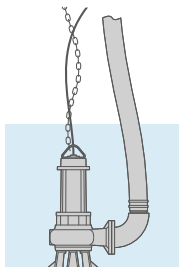

Свободная установка

Электронасос, поддерживаемый основанием, подключен к гибкой напорной трубе при помощи специального соединительного элемента, закрепленного на напорной горловине. Эта установка позволяет легко перемещать электронасос.

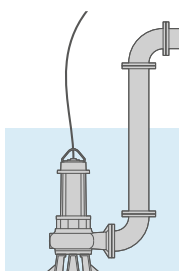

Фиксированная установка

Электронасос, поддерживаемый основанием, подключен к жесткой напорной трубе, привинченной к штуцеру, если он резьбовой, или же прикреплен к напорному колену, если он фланцевый. Соединение насоса и трубы может быть резьбовым или фланцевым, в зависимости от исполнения насоса.

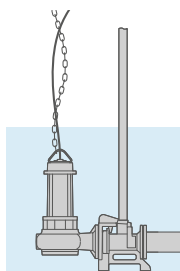
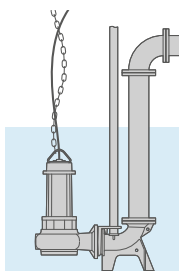

Установка с донным соединительным устройством

Погружная установка, доступна для электронасосов с горизонтальной фланцевой или резьбовой напорной трубой.

Это устройство идеально подходит для фиксированных установок, так как позволяет чрезвычайно легко выполнять периодическую проверку, обслуживание или даже замену электронасоса без опорожнения резервуара.

Можно использовать специальный комплект, позволяющий установку с донной соединительной опорой даже моделей электронасосов с вертикальной напорной трубой.

Способ чтения кода изделия

D G G
3 0 0 / 2 /
G 6 5 V
C 0 E T 5

1
2
3
A
B
C
5
6
7
8
9

4

- | | |
|--|---|
| <p>1 Семейство</p> <p>2 Серия</p> <p>3 Мощность (НРх100)/полюсы двигателя</p> <p>4 Напорное отверстие</p> <p>A Тип (трубная резьба/фланец)</p> <p>B Диаметр (mm)</p> <p>C Направление</p> <p style="margin-left: 20px;">V = вертикальный</p> <p style="margin-left: 20px;">H = горизонтальный</p> | <p>5 Гидравлическая модель</p> <p>6 Номер версии</p> <p>7 Размер двигателя</p> <p>8 Кол. фаз двигателя</p> <p style="margin-left: 20px;">M = Однофазный</p> <p style="margin-left: 20px;">T = Трехфазный</p> <p>9 Частота напряжения питания</p> <p style="margin-left: 20px;">5 = 50Hz</p> <p style="margin-left: 20px;">6 = 60Hz</p> |
|--|---|

Обозначения таблицы технических данных

	1	2	3	4	5	6	7	8	9
	V	1~ 3~	P ₁ [kW] P ₂ [kW]	A	Rpm	DOL Y/Δ			
1 DGG 250/2/65 B0AT5	400	3~	2.2 5.5	3.7	2900	DOL	4G1.5+3x1	DN65	65 mm
2 DGG 300/2/65 C0ET5	400	3~	2.8 8.4	4.6	2900	DOL	4G1.5+3x1	DN65	65 mm

- | | |
|--|---|
| <p>1 Напряжение питания</p> <p>2 Кол. фаз двигателя</p> <p style="margin-left: 20px;">1~ = однофазный</p> <p style="margin-left: 20px;">3~ = трехфазный</p> <p>3 Номинальная мощность</p> <p>4 Номинальный потребляемый ток</p> <p>5 Номинальное количество оборотов в минуту</p> | <p>6 Тип запуска</p> <p style="margin-left: 20px;">DOL = прямой</p> <p style="margin-left: 20px;">Y/Δ = звезда-треугольник</p> <p>7 Тип электрического кабеля</p> <p>8 Диаметр напорной горловины</p> <p>9 Макс. размер твердых тел</p> |
|--|---|



ATEX

По заказу поставляются модели во взрывозащищенной версии **ATEX** для установки в средах с потенциально взрывоопасной пылью,



Маркировка CE соответствия директиве ATEX 2014/34/EU.

2460

Обозначает номер нотифицированного органа (указанного на табличке), который сертифицировал систему менеджмента качества для ATEX



Специальная маркировка взрывозащищенности согласно Прилож. II Директивы ATEX 2014/34/EU.

II

Группа оборудования. Группа II: электрическое оборудование для эксплуатации в потенциально взрывоопасной атмосфере ввиду наличия газов, не являющееся горнопроходческими.

2G

Категория оборудования, являющегося предметом сертификации для потенциально взрывоопасной атмосферы ввиду наличия газа, паров, тумана (G). Оборудование может быть установлено в ЗОНЕ 1

Ex db IIB

Способ использованной для оборудования электрической защиты соответствует защите при помощи взрывозащищенного корпуса, пригодного для газов группы IIB и IIA.

Ex h IIB

Использованный для оборудования способ механической защиты предусматривает погружение в жидкость "к" и конструктивную безопасность "с" - пригодно для газов группы IIB и IIA.

T4

Класс температуры оборудования (максимальная температура поверхности 135°C)

Gb

Оборудование для использования во взрывоопасной атмосфере ввиду присутствия газов с высоким уровнем защиты, которое не является источником воспламенения во время обычной работы или же когда оно претерпевает предусмотренные неисправности

Погружные электронасосы с многоканальной открытой крыльчаткой

Сферы применения

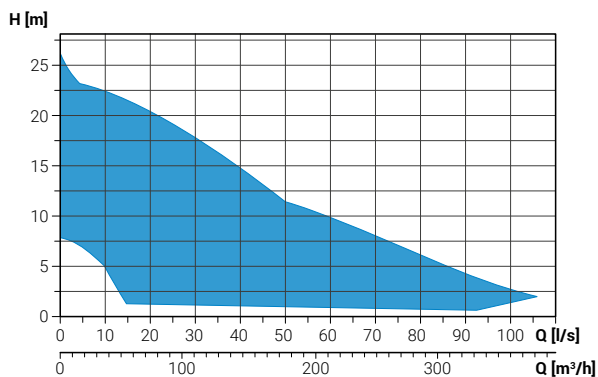

Общие характеристики

Мощность	1.1 ÷ 15.0 kW
Кол. полюсов	2 / 4
Класс изоляции	H
Коэффициент защиты	IP68
Направление вертикальный	G 2½"
Направление горизонтальный	DN65 ÷ DN150
Свободный просвет	max 125 mm
Макс. производительность	106.0 l/s
Макс. напор	24.6 m

Двигатель

Экологический сухой двигатель с тепловой защитой.

Кабель

Кабель S1RN8-F 10 m (стандартная версия)

Механические уплотнения

Два механических уплотнения из карбида кремния (2SiC), оба устанавливаемых в камере с маслом

Назначение оборудования

Находит применение при наличии биологических загрязненных жидкостей и канализационных неотфильтрованных стоков, а также для подъема гражданских стоков. Отлично подходит для использования в очистных сооружениях, канализационных системах, животноводческих фермах, в промышленности и сельском хозяйстве.

Установка

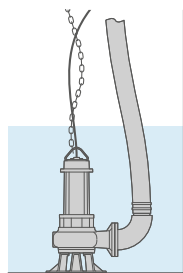

Свободная установка

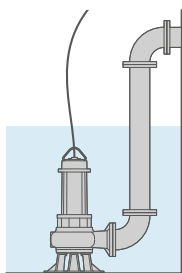

Фиксированная установка

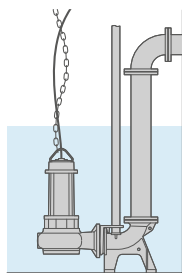

Установка с донным соединительным устройством

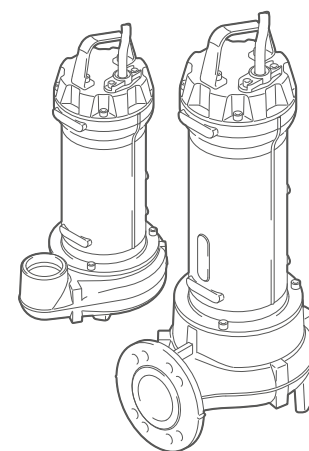
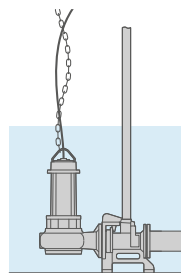

Доступные версии

Электрические варианты	NAE, TS
Система охлаждения	N
Механические уплотнения	2SiC

Ограничения по эксплуатации

Макс. температура эксплуатации	40 °C
РН обработанной жидкости	6 ÷ 14
Вязкость обработанной жидкости	1 mm²/s
Макс. глубина погружения	20 m
Плотность обработанной жидкости	1 Kg/dm³
Макс. акустическое давление	<70dB
Макс. запусков/час	30

Материалы для изготовления

Каркас	Чугун EN-GJL 250
Гидравлическая часть	Чугун EN-GJL 250
Материал крыльчатки	Чугун EN-GJL 250
Крепеж	Нержавеющая сталь - Класс A2-70
Стандартное уплотнение	Резина - NBR
Вал	Нержавеющая сталь - AISI 431
Окраска	Эпоксидная, двухкомпонентная, на водной основе (средняя толщина ~200 мкм)
Системы измельчения	-
Всасывающая решетка	-

DGG 75÷150/2/G40V

Характеристики

	l/s	0	1	2	3	4	5	6	7
	l/min	0	60	120	180	240	300	360	420
	m ³ /h	0	3.6	7.2	10.8	14.4	18	21.6	25.2
1	DGG 75/2/G40V B3AM5								
	DGG 75/2/G40V B3AT5	8.6	7.9	6.8	5.3	3.5	1.9		
2	DGG 100/2/G40V B3AM5								
	DGG 100/2/G40V B3AT5	11.0	10.2	9.1	7.9	6.4	4.3	2.1	
3	DGG 150/2/G40V C3AM5								
	DGG 150/2/G40V C3AT5	14.1	12.9	11.7	10.6	9.0	6.9	4.5	2.0

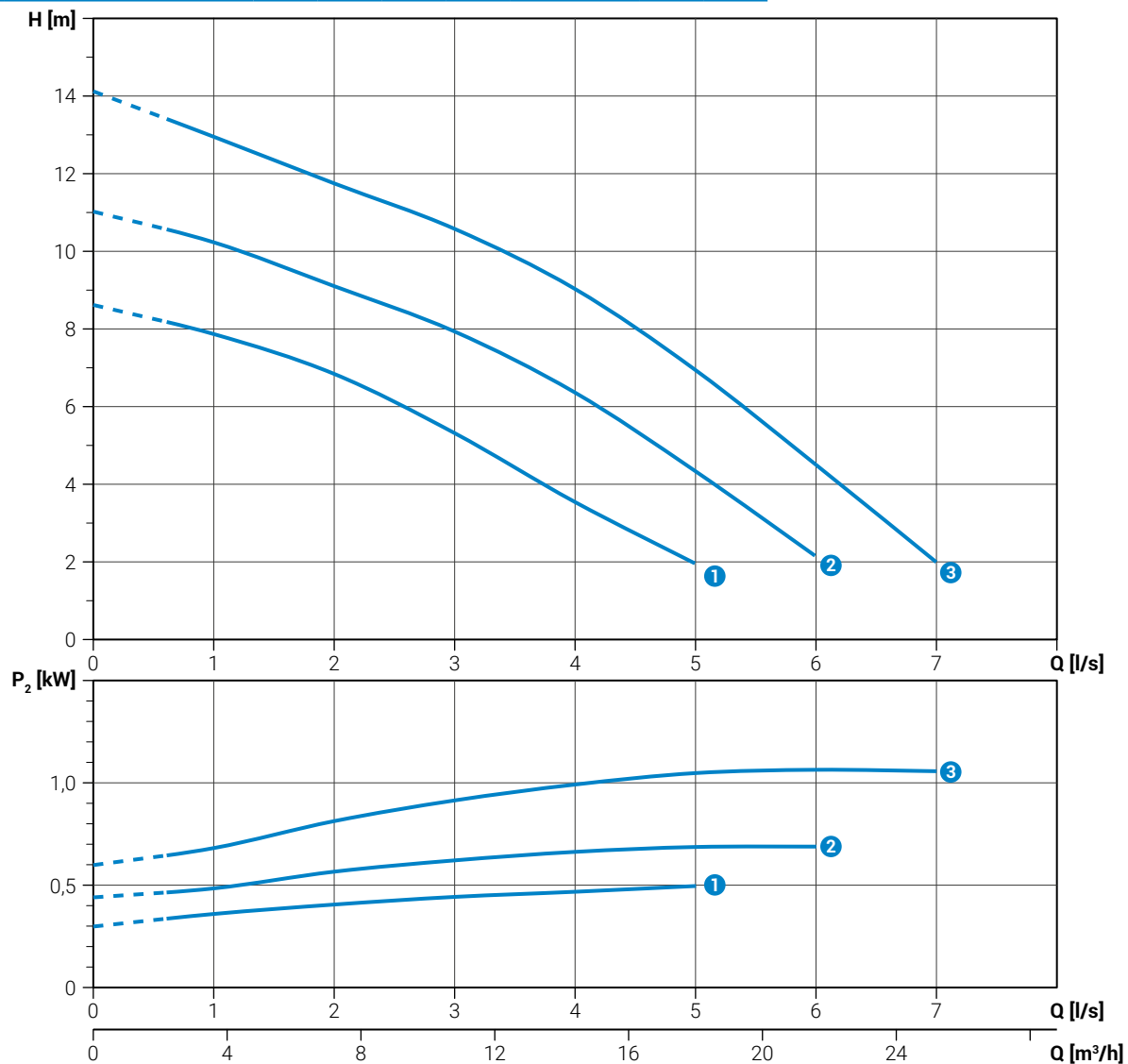

Диапазоны мощностей соответствуют нормативу UNI EN ISO 9906

Технические данные

	V	1~ 3~	P ₁ [kW]	P ₂ [kW]	A	Rpm	DOL Y/Δ				
1	DGG 75/2/G40V B3AM5	400	1~	0.8	0.6	4.2	2900	-	4G1.5+3x1	G1 ¹ / ₂	35 mm
	DGG 75/2/G40V B3AT5	400	3~	0.7	0.6	1.4	2900	DOL	4G1.5+3x1	G1 ¹ / ₂	35 mm
2	DGG 100/2/G40V B3AM5	400	1~	1.0	0.8	4.9	2900	-	4G1.5+3x1	G1 ¹ / ₂	35 mm
	DGG 100/2/G40V B3AT5	400	3~	0.9	0.8	1.7	2900	DOL	4G1.5+3x1	G1 ¹ / ₂	35 mm
3	DGG 150/2/G40V C3AM5	400	1~	1.4	1.1	6.6	2900	-	4G1.5+3x1	G1 ¹ / ₂	35 mm
	DGG 150/2/G40V C3AT5	400	3~	1.3	1.1	2.4	2900	DOL	4G1.5+3x1	G1 ¹ / ₂	35 mm

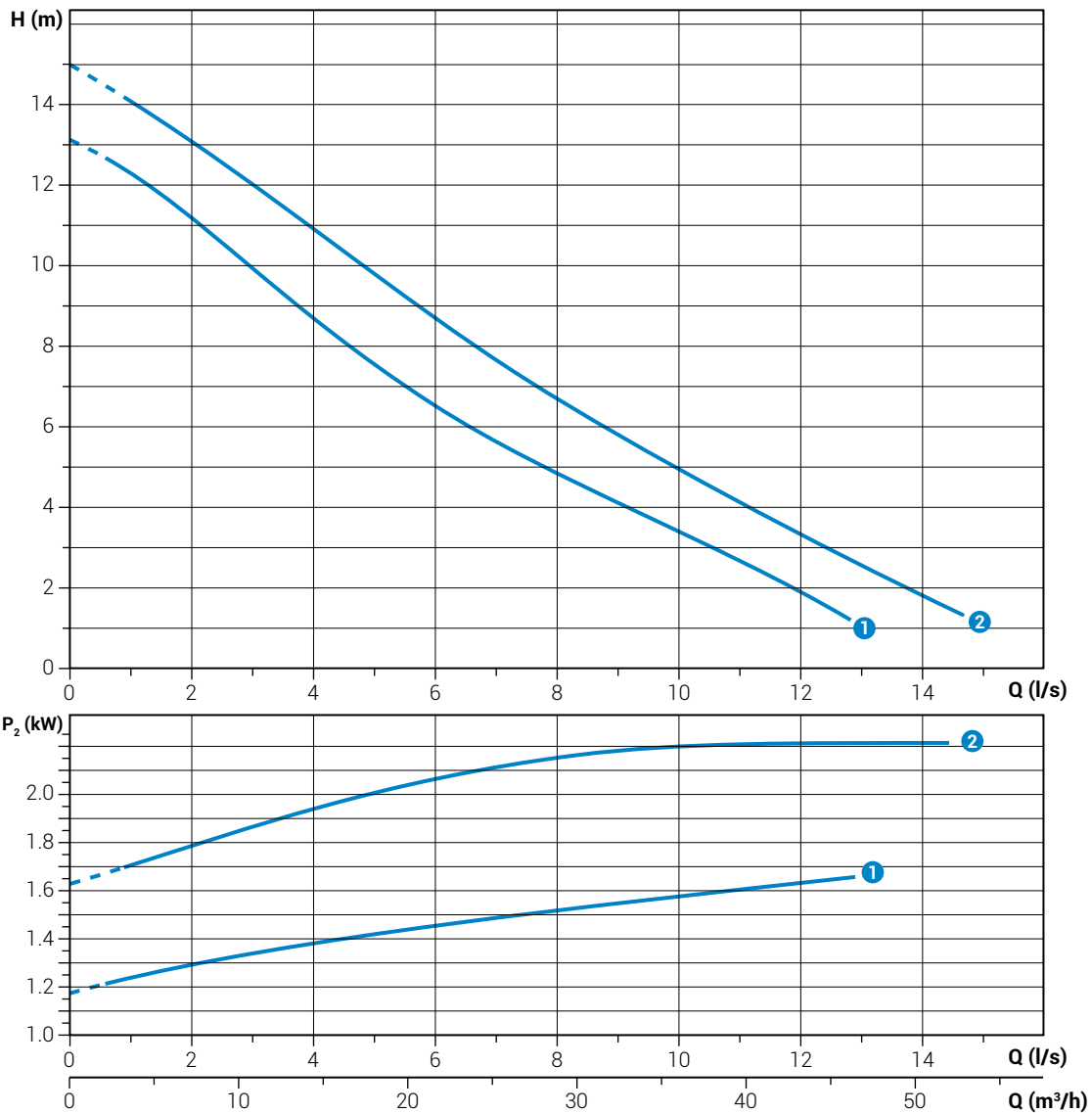

**DGG 250÷300/2/G65V****Характеристики**

	l/s	0	2	4	6	8	10	12	14
	l/min	0	120	240	360	480	600	720	840
	m ³ /h	0	7.2	14.4	21.6	28.8	36.0	43.2	50.4
①	DGG 250/2/G65V B0AT5	13.0	11.2	8.7	6.5	4.8	3.4	2.0	
②	DGG 300/2/G65V A0ET5	15.0	13.1	10.9	8.7	6.7	4.9	3.4	1.9



Диапазоны мощности соответствуют нормативу UNI EN ISO 9906

Технические данные

	V	1~ 3~	P ₁ [kW]	P ₂ [kW]	A	Rpm	DOL Y/Δ				
①	DGG 250/2/G65V B0AT5	400	3~	2.2	1.8	3.7	2900	DOL	4G1	G2½"	65 mm
②	DGG 300/2/G65V A0ET5	400	3~	2.8	2.2	4.6	2900	DOL	4G1.5+3x1	G2½"	65 mm



DGG 75÷100/2/G50H

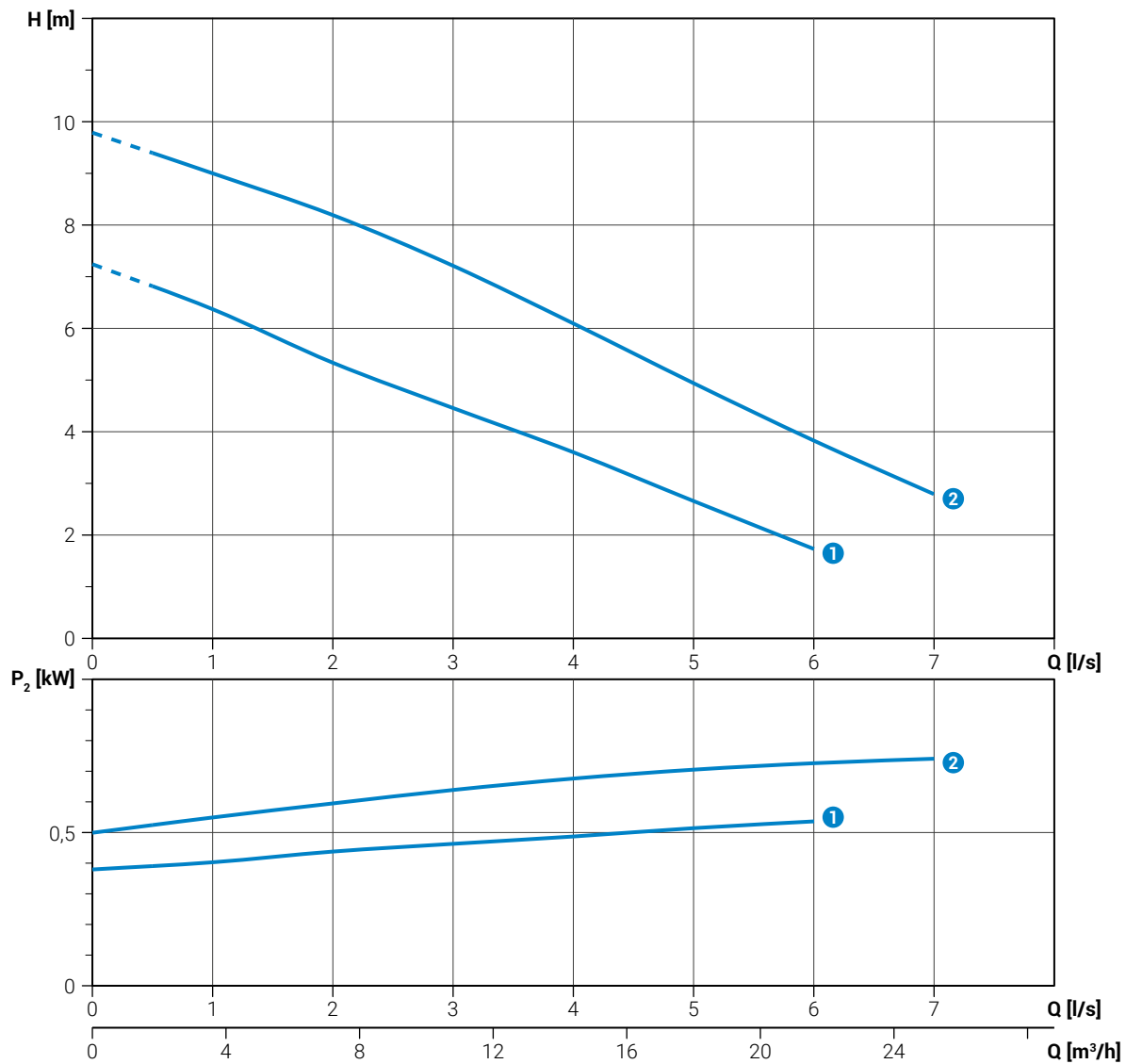

Характеристики

	l/s	0	1	2	3	4	5	6	7
	l/min	0	60	120	180	240	300	360	420
	m ³ /h	0	3.6	7.2	10.8	14.4	18	21.6	25.2
1	DGG 75/2/G50H A3AM5								
	DGG 75/2/G50H A3AT5	7,2	6,4	5,3	4,4	3,6	2,6	1,7	
2	DGG 100/2/G50H A3AM5								
	DGG 100/2/G50H A3AT5	9,8	9,0	8,2	7,2	6,1	4,9	3,8	2,8



Диапазоны мощностей соответствуют нормативу UNI EN ISO 9906

Технические данные

	V	1~ 3~	P ₁ [kW]	P ₂ [kW]	A	Rpm	DOL Y/Δ				
1	DGG 75/2/G50H A3AM5	400	1~	0.8	0.6	4.2	2900	-	4G1.5+3x1	G1"½ DN32	50 mm
	DGG 75/2/G50H A3AT5	400	3~	0.7	0.6	1.4	2900	DOL	4G1.5+3x1	G1"½ DN32	50 mm
2	DGG 100/2/G50H A3AM5	400	1~	1.0	0.8	4.9	2900	-	4G1.5+3x1	G1"½ DN32	50 mm
	DGG 100/2/G50H A3AT5	400	3~	0.8	0.9	1.7	2900	DOL	4G1.5+3x1	G1"½ DN32	50 mm

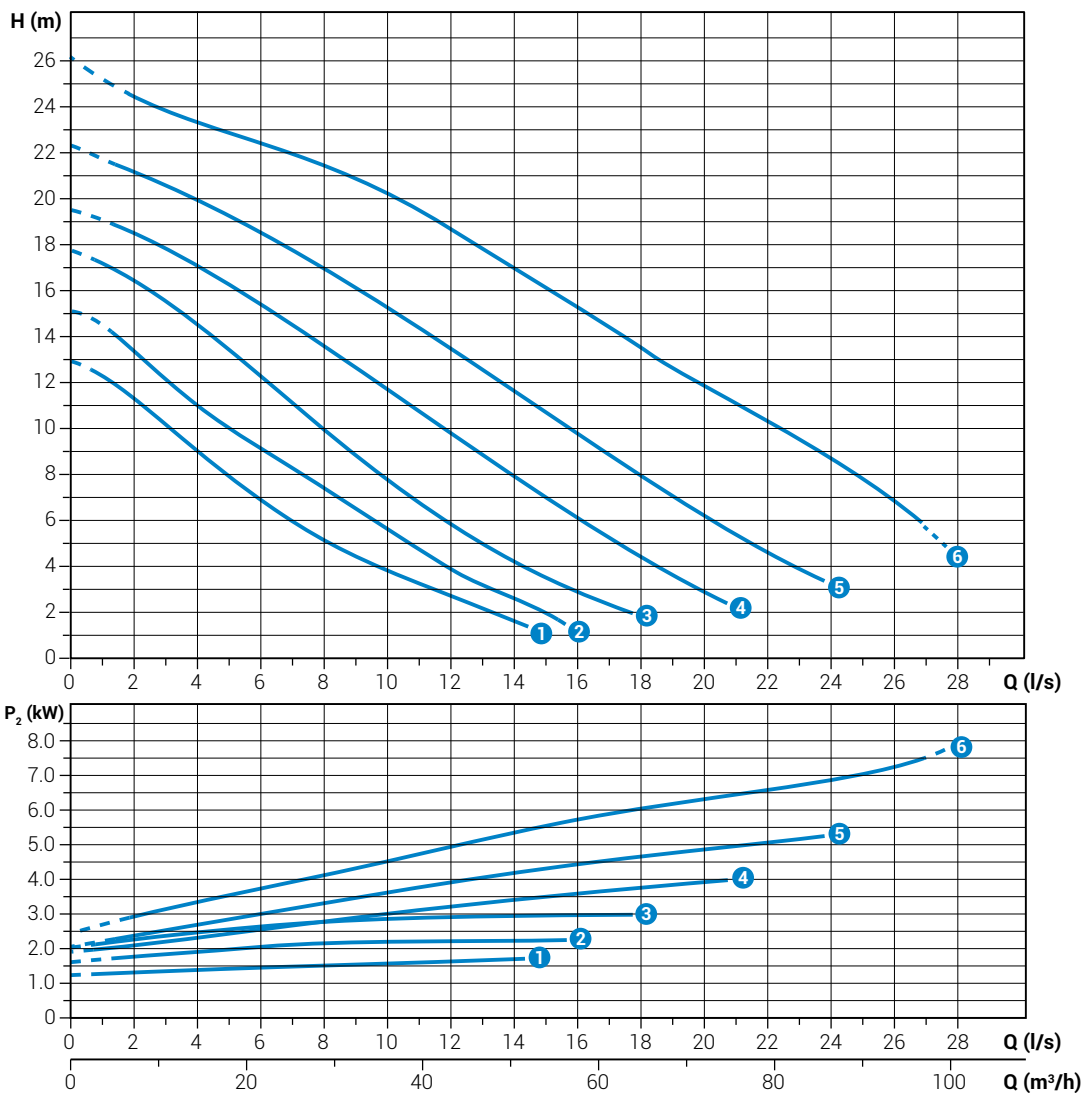

**DGG 250÷1000/2/65****Характеристики**

	l/s	0	2	4	6	8	10	12	14	16	18	20	22	24	26
	l/min	0	120	240	360	480	600	720	840	960	1080	1200	1320	1440	1560
	m ³ /h	0	7.2	14.4	21.6	28.8	36.0	43.2	50.4	57.6	64.8	72.0	79.2	86.4	93.6
1 DGG 250/2/65 B0AT5		13.0	11.3	9.0	6.9	5.2	3.8	2.7	16						
2 DGG 300/2/65 C0ET5		15.1	13.4	11.0	9.1	7.4	5.6	3.9	2.6						
3 DGG 400/2/65 D0ET5		17.7	16.4	14.5	12.2	9.9	7.7	5.8	4.2	2.9					
4 DGG 550/2/65 A0FT5		19.5	18.4	17.0	15.4	13.6	11.7	9.8	7.9	6.1	4.4	2.9			
5 DGG 750/2/65 A0FT5		22.3	21.2	19.9	18.6	17.0	15.3	13.5	11.6	9.8	7.9	6.2	4.7		
6 DGG 1000/2/65 A0FT5		26.1	24.4	23.3	22.4	21.4	20.2	18.7	17.0	15.3	13.5	11.8	10.3	8.7	6.8



Диапазоны мощности соответствуют нормативу UNI EN ISO 9906

Технические данные

	V	1~ 3~	P ₁ [kW]	P ₂ [kW]	A	Rpm	DOL Y/Δ			
1 DGG 250/2/65 B0AT5	400	3~	2.2	1.8	3.7	2900	DOL	4G1	DN65	65 mm
2 DGG 300/2/65 C0ET5	400	3~	2.8	2.2	4.6	2900	DOL	4G1.5+3x1	DN65	65 mm
3 DGG 400/2/65 D0ET5	400	3~	3.7	3.0	6.4	2900	DOL	4G1.5+3x1	DN65	65 mm
4 DGG 550/2/65 A0FT5	400	3~	4.7	4.0	7.7	2900	DOL	4G1.5+3x1	DN65	65 mm
5 DGG 750/2/65 A0FT5	400	3~	6.3	5.5	10.8	2900	DOL	4G1.5+3x1	DN65	65 mm
6 DGG 1000/2/65 A0FT5	400	3~	8.5	7.5	13.7	2900	DOL	4G1.5+3x1	DN65	65 mm

DGG 250÷1000/2/80

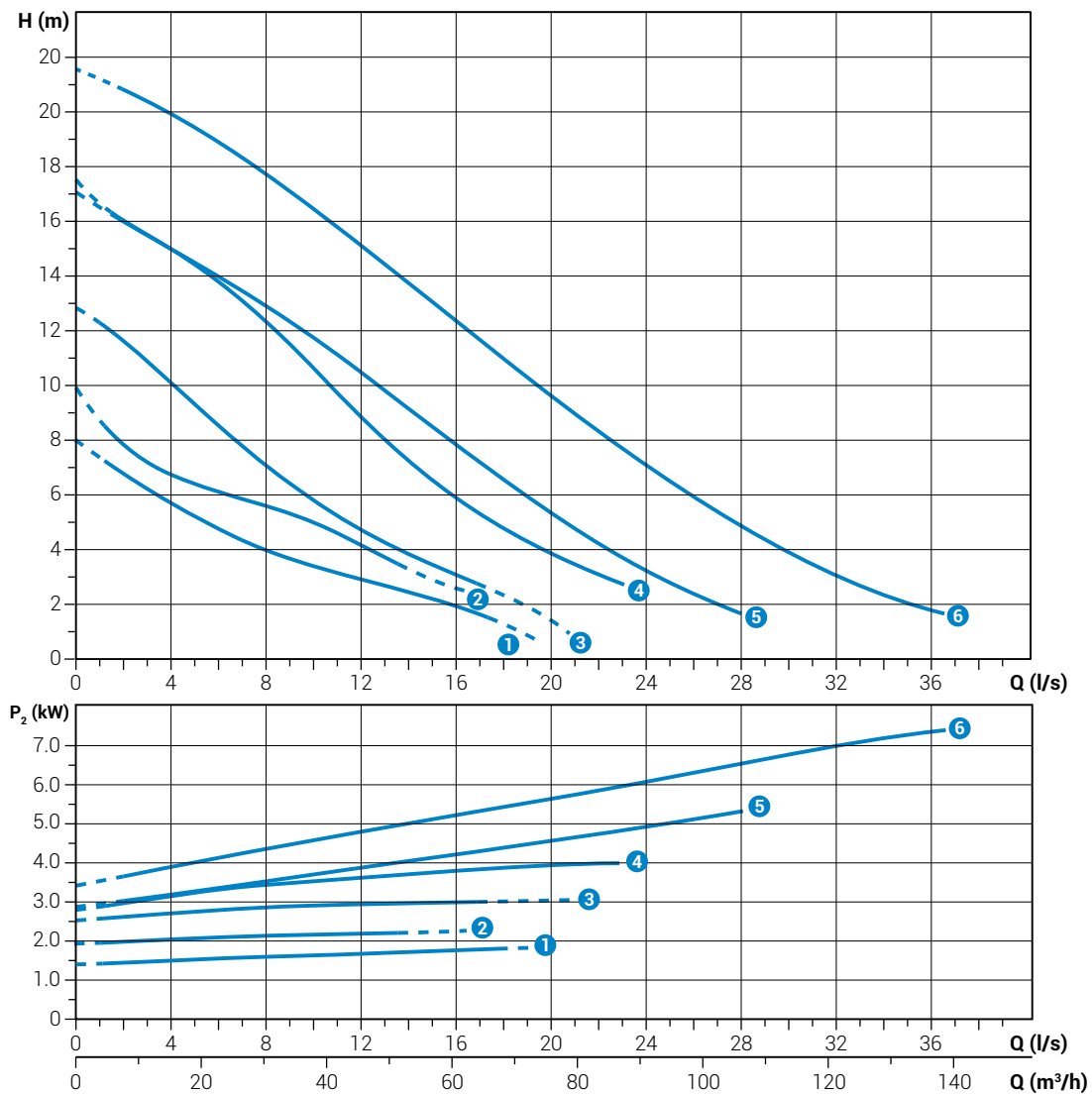

Характеристики

	l/s	0	4	8	12	16	20	24	28	32	36
	l/min	0	240	480	720	960	1200	1440	1680	1920	2160
	m³/h	0	14.4	28.8	43.2	57.6	72.0	86.4	100.8	115.2	129.6
1	DGG 250/2/80 F0AT5	7.9	5.7	4.0	2.9	1.9					
2	DGG 300/2/80 G0ET5	9.7	6.7	5.6	4.2	2.6					
3	DGG 400/2/80 H0ET5	12.8	10.1	7.1	4.7	3.1	1.4				
4	DGG 550/2/80 N0FT5	17.5	15.0	12.4	8.9	5.9	3.9				
5	DGG 750/2/80 A0FT5	17.1	15.1	12.9	10.5	7.8	5.3	3.2	1.7		
6	DGG 1000/2/80 A0FT5	21.6	20.0	17.7	15.1	12.4	9.6	7.1	4.8	3.0	1.8



Диапазоны мощностей соответствуют нормативу UNI EN ISO 9906

Технические данные

	V	1~ 3~	P ₁ [kW]	P ₂ [kW]	A	Rpm	DOL Y/Δ				
1	DGG 250/2/80 F0AT5	400	3~	2.2	1.8	3.7	2900	DOL	4G1	DN80	80 mm
2	DGG 300/2/80 G0ET5	400	3~	2.8	2.2	4.6	2900	DOL	4G1.5+3x1	DN80	80 mm
3	DGG 400/2/80 H0ET5	400	3~	3.7	3.0	6.4	2900	DOL	4G1.5+3x1	DN80	80 mm
4	DGG 550/2/80 N0FT5	400	3~	4.7	4.0	7.7	2900	DOL	4G1.5+3x1	DN80	80 mm
5	DGG 750/2/80 A0FT5	400	3~	6.3	5.5	10.8	2900	DOL	4G1.5+3x1	DN80	80 mm
6	DGG 1000/2/80 A0FT5	400	3~	8.5	7.5	13.7	2900	DOL	4G1.5+3x1	DN80	80 mm

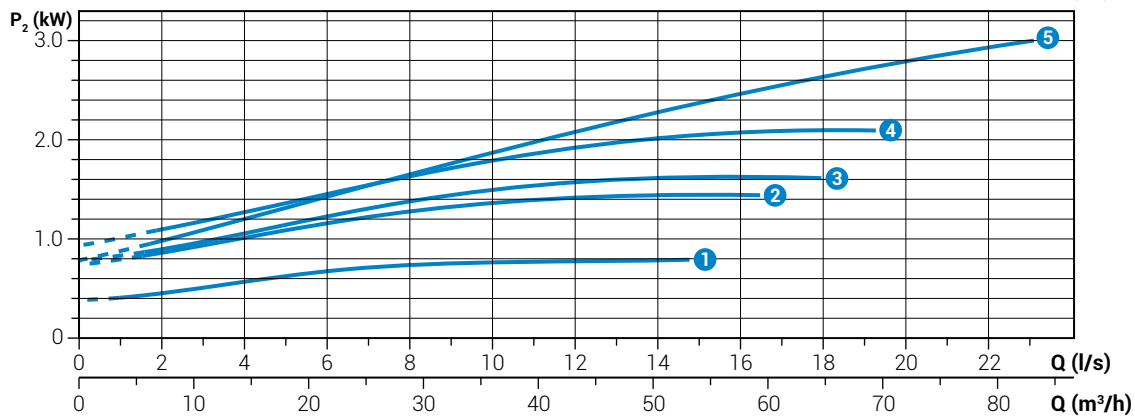
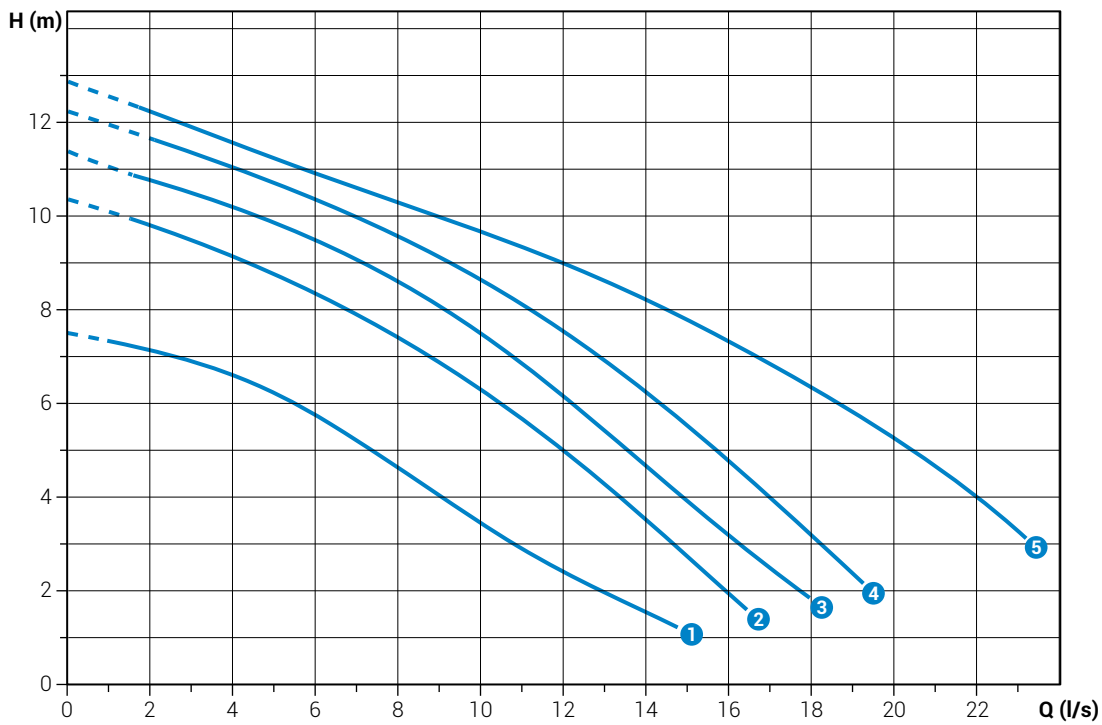

**DGG 150÷400/4/65****Характеристики**

	l/s	0	2	4	6	8	10	12	14	16	18	20	22
	l/min	0	120	240	360	480	600	720	840	960	1080	1200	1320
	m ³ /h	0	7.2	14.4	21.6	28.8	36.0	43.2	50.4	57.6	64.8	72.0	79.2
1	DGG 150/4/65 H0AT5	7.5	7.2	6.6	5.8	4.6	3.4	2.4	1.6				
2	DGG 200/4/65 F0ET5	10.4	9.8	9.2	8.4	7.4	6.3	5.0	3.6	2.0			
3	DGG 250/4/65 F0ET5	11.3	10.8	10.2	9.5	8.6	7.5	6.2	4.7	3.2			
4	DGG 300/4/65 F0ET5	12.2	11.6	11.0	10.4	9.6	8.7	7.6	6.3	4.8	3.2		
5	DGG 400/4/65 G0ET5	12.8	12.2	11.5	10.9	10.3	9.7	9.0	8.2	7.3	6.3	5.3	4.0



Диапазоны мощности соответствуют нормативу UNI EN ISO 9906

Технические данные

	V	1~ 3~	P ₁ [kW]	P ₂ [kW]	A	Rpm	DOL Y/Δ				
1	DGG 150/4/65 H0AT5	400	3~	1.5	1.1	3.0	1450	DOL	4G1	DN65	45 mm
2	DGG 200/4/65 F0ET5	400	3~	1.8	1.5	3.4	1450	DOL	4G1.5+3x1	DN65	65 mm
3	DGG 250/4/65 F0ET5	400	3~	2.2	1.8	4.3	1450	DOL	4G1.5+3x1	DN65	65 mm
4	DGG 300/4/65 F0ET5	400	3~	2.7	2.2	5.2	1450	DOL	4G1.5+3x1	DN65	65 mm
5	DGG 400/4/65 G0ET5	400	3~	3.7	3.0	6.7	1450	DOL	4G1.5+3x1	DN65	65 mm

DGG 150÷300/4/80

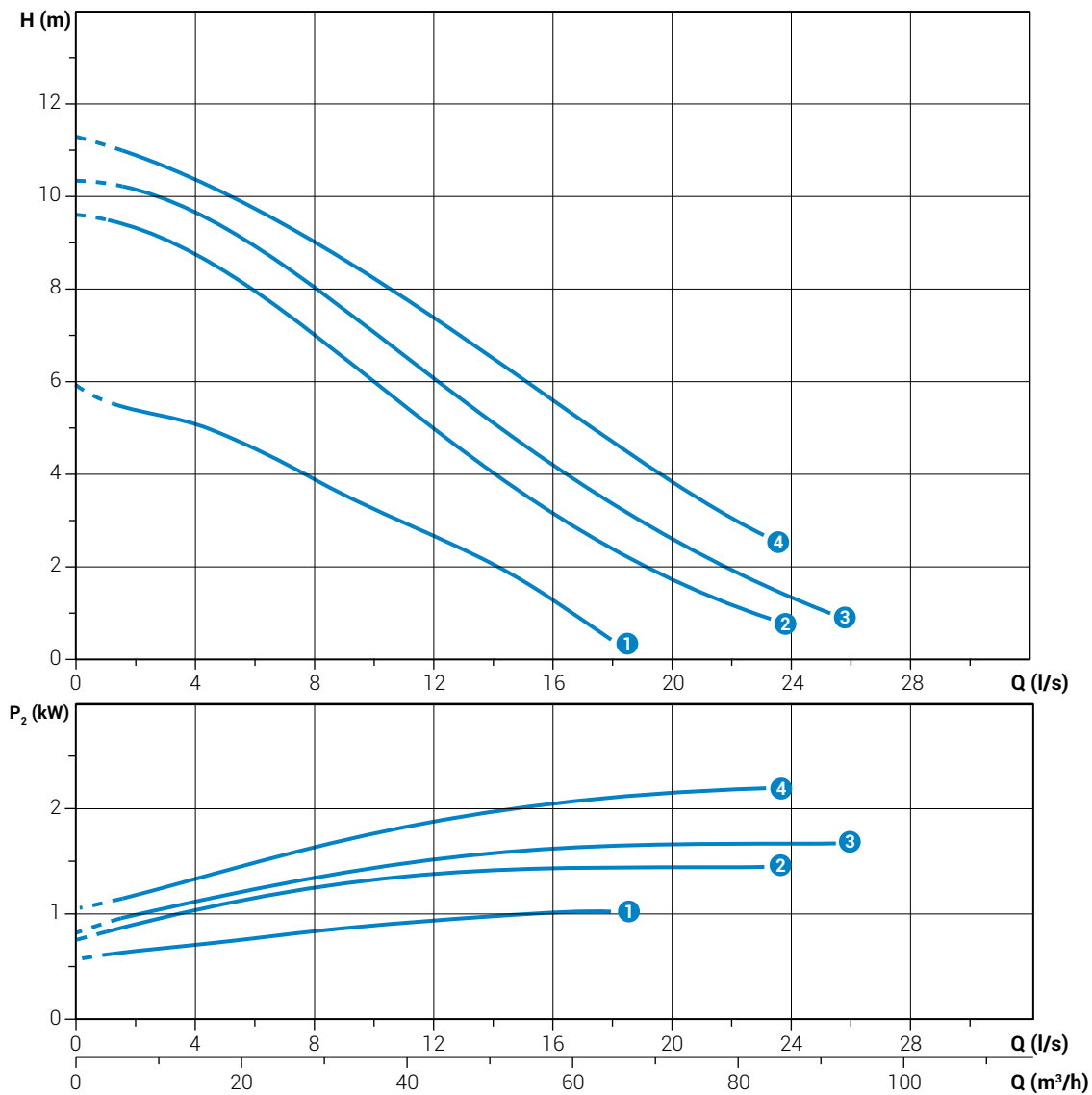

Характеристики

	l/s	0	4	8	12	16	20	24
	l/min	0	240	480	720	960	1200	1440
	m³/h	0	14.4	28.8	43.2	57.6	72.0	86.4
1	DGG 150/4/80 LOAT5	5.9	5.1	3.9	2.7	1.3		
2	DGG 200/4/80 E0ET5	9.6	8.8	7.0	5.0	3.2	1.7	
3	DGG 250/4/80 E0ET5	10.4	9.7	8.1	6.1	4.2	2.6	1.3
4	DGG 300/4/80 E0ET5	11.3	10.4	9.0	7.4	5.6	3.8	



Диапазоны мощности соответствуют нормативу UNI EN ISO 9906

Технические данные

	V	1~ 3~	P ₁ [kW]	P ₂ [kW]	A	Rpm	DOL Y/Δ				
1	DGG 150/4/80 LOAT5	400	3~	1.5	1.1	3.0	1450	DOL	4G1	DN80	80 mm
2	DGG 200/4/80 E0ET5	400	3~	1.8	1.5	3.4	1450	DOL	4G1.5+3x1	DN80	80 mm
3	DGG 250/4/80 E0ET5	400	3~	2.2	1.8	4.3	1450	DOL	4G1.5+3x1	DN80	80 mm
4	DGG 300/4/80 E0ET5	400	3~	2.7	2.2	5.2	1450	DOL	4G1.5+3x1	DN80	80 mm

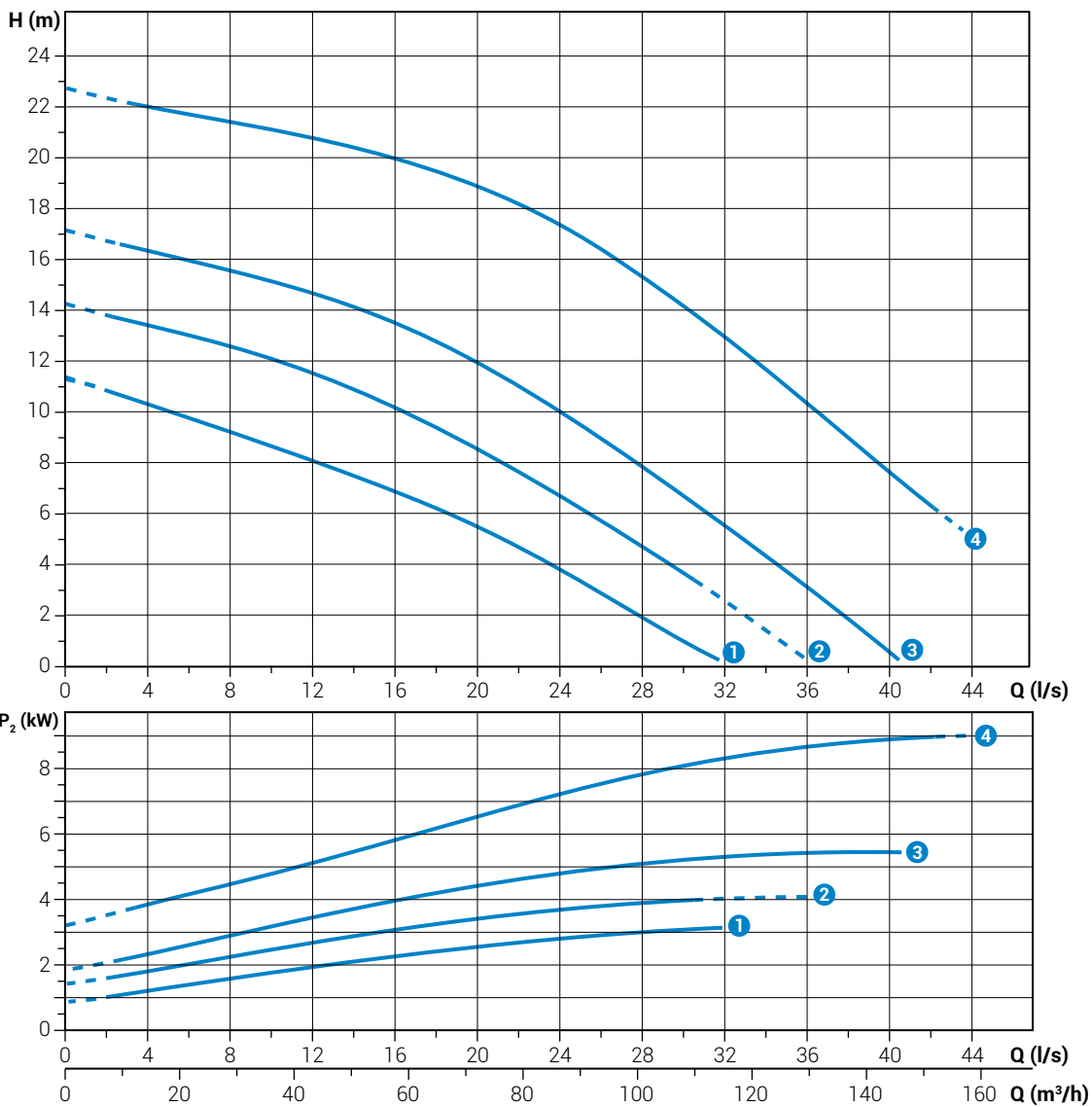

**DGG 400÷1200/4/80****Характеристики**

	l/s	0	4	8	12	16	20	24	28	32	36	40
	l/min	0	240	480	720	960	1200	1440	1680	1920	2160	2400
	m ³ /h	0	14.4	28.8	43.2	57.6	72.0	86.4	100.8	115.2	129.6	144
①	DGG 400/4/80 M0ET5	11.4	10.3	9.2	8.1	6.9	5.5	3.8	1.9			
②	DGG 550/4/80 D0FT5	14.4	13.5	12.7	11.6	10.2	8.6	6.7	4.7			
③	DGG 750/4/80 D0FT5	17.2	16.4	15.6	14.7	13.5	12.0	10.0	7.8	5.5	3.1	0.6
④	DGG 1200/4/80 D0HT5	22.8	22.0	21.4	20.8	20.0	18.9	17.3	15.4	13.0	10.4	7.7



Диапазоны мощности соответствуют нормативу UNI EN ISO 9906

Технические данные

	V	1~ 3~	P ₁ [kW]	P ₂ [kW]	A	Rpm	DOL Y/Δ				
①	DGG 400/4/80 M0ET5	400	3~	3.7	3.0	6.7	1450	DOL	4G1.5+3x1	DN80	80 mm
②	DGG 550/4/80 D0FT5	400	3~	4.6	4.0	8.4	1450	DOL	4G1.5+3x1	DN80	60 mm
③	DGG 750/4/80 D0FT5	400	3~	6.4	5.5	11.8	1450	DOL	4G1.5+3x1	DN80	60 mm
④	DGG 1200/4/80 D0HT5	400	3~	10.2	9.0	17.0	1450	Y/Δ	7G1.5+3x1	DN80	60 mm

DGG 200÷550/4/100

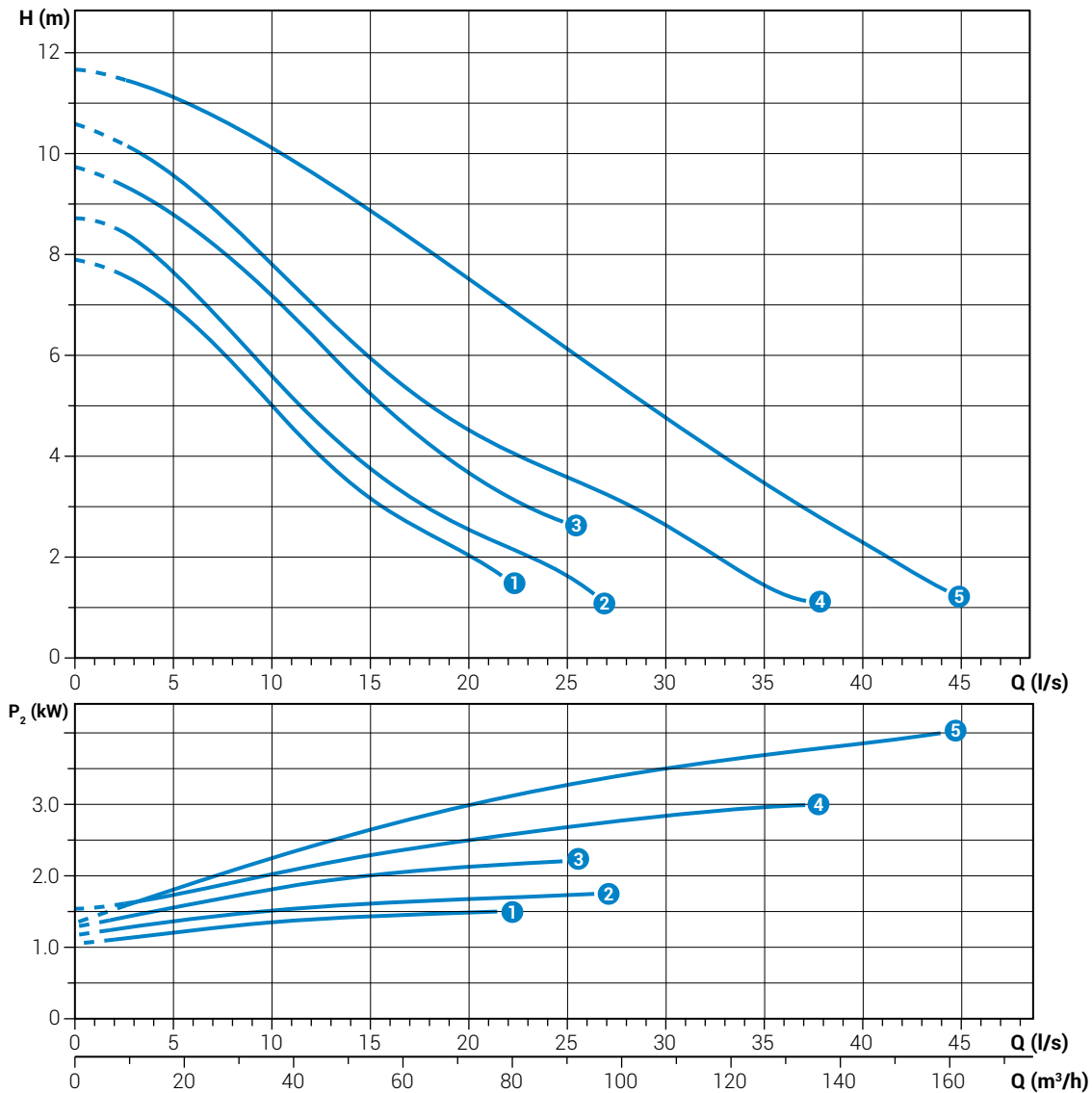

Характеристики

	l/s	0	4	8	12	16	20	24	28	32	36	40	44
	l/min	0	240	480	720	960	1200	1440	1680	1920	2160	2400	2640
	m ³ /h	0	14.4	28.8	43.2	57.6	72	86.4	100.8	115.2	129.6	144	158.4
① DGG 200/4/100 E0ET5		7.9	7.2	5.8	4.2	2.9	2.1						
② DGG 250/4/100 E0ET5		8.7	8.0	6.4	4.8	3.5	2.6	1.8					
③ DGG 300/4/100 E0ET5		9.7	9.1	7.9	6.4	4.9	3.7	2.9					
④ DGG 400/4/100 D0ET5		10.6	9.8	8.6	7.0	5.6	4.5	3.8	3.1	2.2	1.3		
⑤ DGG 550/4/100 G0FT5		11.7	11.3	10.6	9.7	8.6	7.6	6.4	5.3	4.2	3.2	2.3	1.4



Диапазоны мощности соответствуют нормативу UNI EN ISO 9906

Технические данные

	V	1~ 3~	P ₁ [kW]	P ₂ [kW]	A	Rpm	DOL Y/Δ			
① DGG 200/4/100 E0ET5	400	3~	1.84	1.5	3.4	1450	DOL	4G1.5+3x1	DN100	100 mm
② DGG 250/4/100 E0ET5	400	3~	2.22	1.8	4.3	1450	DOL	4G1.5+3x1	DN100	100 mm
③ DGG 300/4/100 E0ET5	400	3~	2.7	2.2	5.15	1450	DOL	4G1.5+3x1	DN100	100 mm
④ DGG 400/4/100 D0ET5	400	3~	3.68	3.0	6.7	1450	DOL	4G1.5+3x1	DN100	100 mm
⑤ DGG 550/4/100 G0FT5	400	3~	4.62	4.0	8.4	1450	DOL	4G1.5+3x1	DN100	80 mm

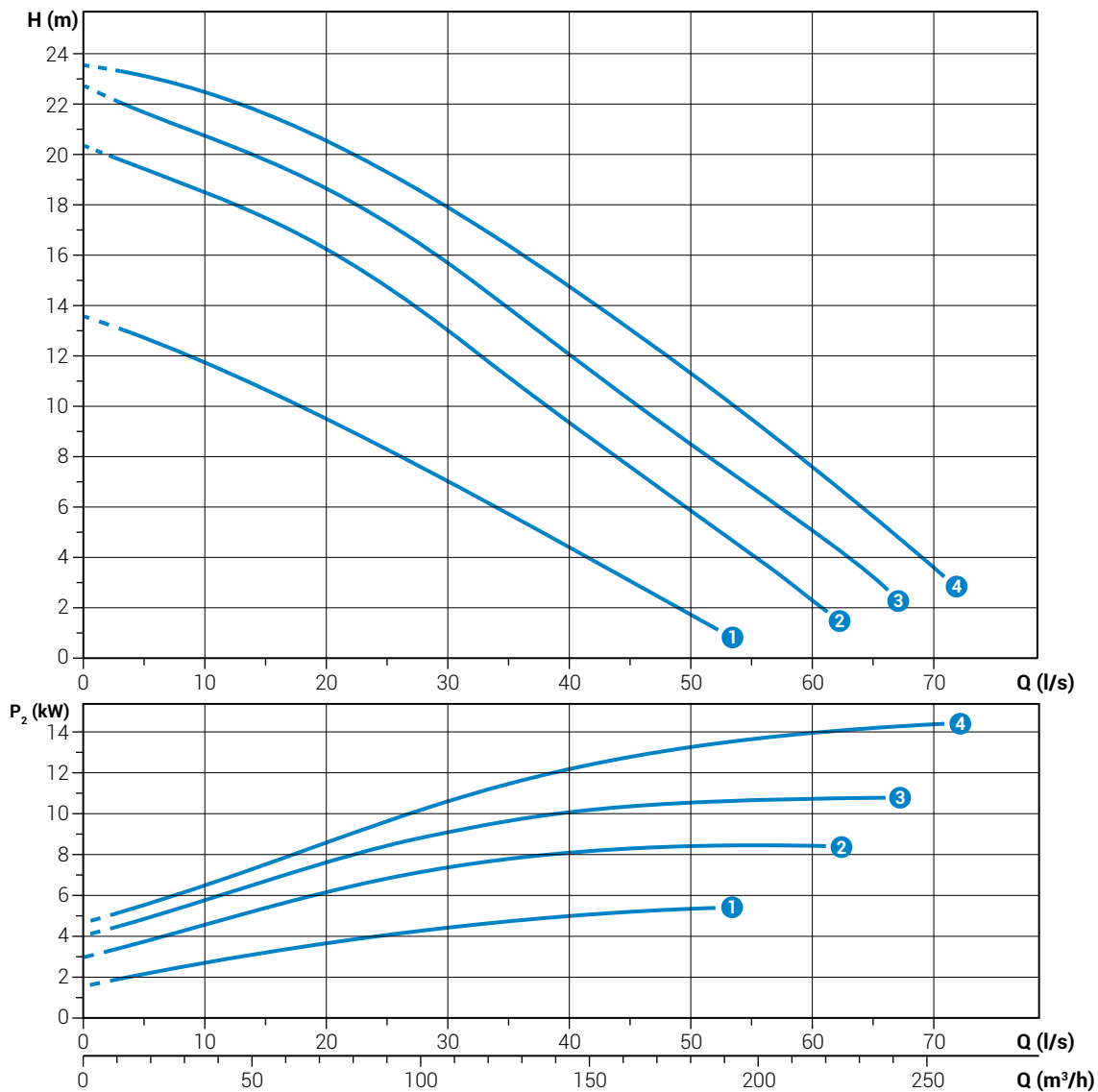

**DGG 750÷2000/4/100****Характеристики**

	l/s	0	8	16	24	32	40	48	56	64
	l/min	0	480	960	1440	1920	2400	2880	3360	3840
	m ³ /h	0	28.8	57.6	86.4	115.2	144.0	172.8	201.6	230.4
1	DGG 750/4/100 G0FT5	13.5	12.1	10.4	8.5	6.6	4.4	2.3		
2	DGG 1200/4/100 B0HT5	20.3	18.8	17.2	15.0	12.3	9.3	6.5	3.8	
3	DGG 1500/4/100 B0HT5	22.7	21.1	19.6	17.6	15.0	12.1	9.2	6.4	3.6
4	DGG 2000/4/100 B0HT5	23.5	22.8	21.4	19.5	17.3	14.8	12.1	9.1	6.0



Диапазоны мощности соответствуют нормативу UNI EN ISO 9906

Технические данные

	V	1~ 3~	P ₁ [kW]	P ₂ [kW]	A	Rpm	DOL Y/Δ				
1	DGG 750/4/100 G0FT5	400	3~	6.4	5.5	11.8	1450	DOL	4G1.5+3x1	DN100	80 mm
2	DGG 1200/4/100 B0HT5	400	3~	10.2	9.0	17.0	1450	Y/Δ	7G1.5+3x1	DN100	100 mm
3	DGG 1500/4/100 B0HT5	400	3~	12.6	11.0	20.5	1450	Y/Δ	7G1.5+3x1	DN100	100 mm
4	DGG 2000/4/100 B0HT5	400	3~	16.7	15.0	30.8	1450	Y/Δ	7G1.5+3x1	DN100	100 mm



DGG 1200÷2000/4/150

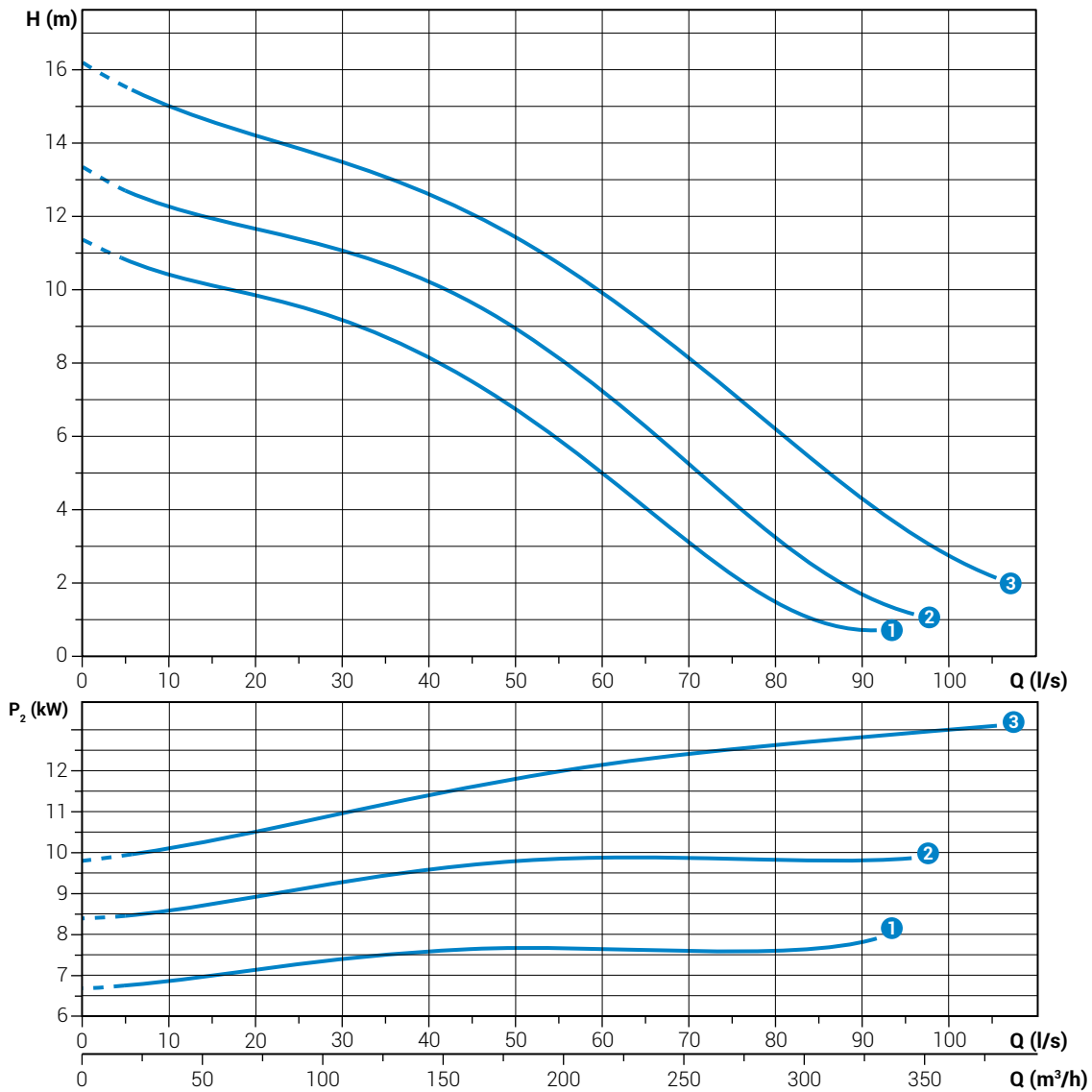

Характеристики

	l/s	0	8	16	24	32	40	48	56	64	72	80	88	96	104
	l/min	0	480	960	1440	1920	2400	2880	3360	3840	4320	4800	5280	5760	6240
	m³/h	0	28.8	57.6	86.4	115.2	144	172.8	201.6	230.4	259.2	288	316.8	345.6	374.4
① DGG 1200/4/150 A0HT5		11.3	10.6	10.1	9.6	9.0	8.2	7.1	5.7	4.2	2.7	1.5	0.8		
② DGG 1500/4/150 A0HT5		13.3	12.4	11.8	11.4	10.9	10.2	9.2	8.0	6.5	4.8	3.3	1.9		
⑤ DGG 2000/4/150 A0HT5		16.2	15.2	14.5	13.9	13.3	12.6	11.7	10.6	9.2	7.7	6.2	4.6	3.3	2.3



Диапазоны мощности соответствуют нормативу UNI EN ISO 9906

Технические данные

	V	1~ 3~	P ₁ [kW]	P ₂ [kW]	A	Rpm	DOL Y/Δ			
① DGG 1200/4/150 A0HT5	400	3~	10.2	9.0	17.0	1450	Y/Δ	7G1.5+3x1	DN150	125 mm
② DGG 1500/4/150 A0HT5	400	3~	12.6	11.0	20.5	1450	Y/Δ	7G1.5+3x1	DN150	125 mm
⑤ DGG 2000/4/150 A0HT5	400	3~	16.7	15.0	30.8	1450	Y/Δ	7G2.5+3x1	DN150	125 mm

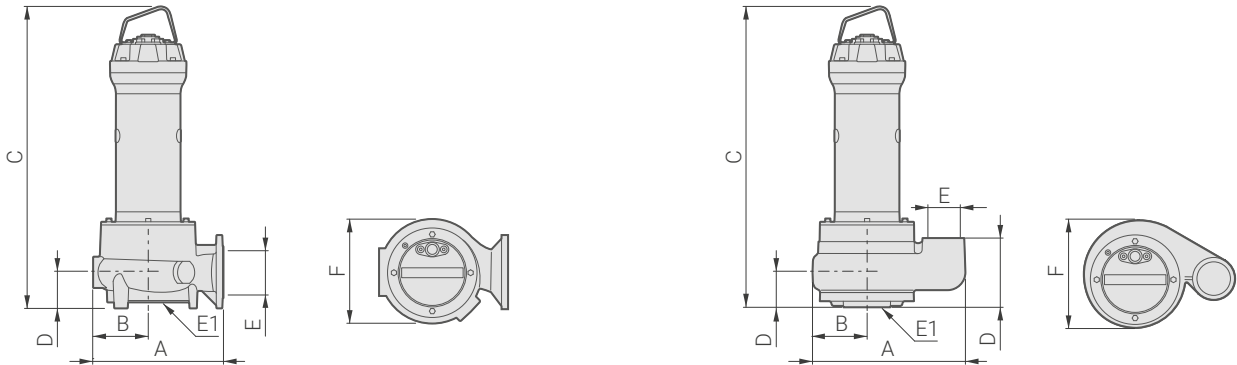
**DGG**

	A	B	C	D	E	E1	F	kg
DGG 75/2/G40V B3AM5	274	110	510	152	G1½"	-	220	26.0
DGG 75/2/G40V B3AT5	274	110	510	152	G1½"	-	220	26.0
DGG 100/2/G40V B3AM5	274	110	510	152	G1½"	-	220	27.0
DGG 100/2/G40V B3AT5	274	110	510	152	G1½"	-	220	27.0
DGG 150/2/G40V C3AM5	259	102	543	115	G1½"	-	205	28.5
DGG 150/2/G40V C3AT5	259	102	543	115	G1½"	-	205	28.5
DGG 250/2/G65V B0AT5	311	109	553	133	G2½"	65	219	35.0
DGG 300/2/G65V A0ET5	311	109	576	133	G2½"	65	219	44.2

	A	B	C	D	E	E1	F		kg
DGG 75/2/G50H A3AM5	254	110	525	110	G2"	-	220	DN32 PN6	27.0
DGG 75/2/G50H A3AT5	254	110	525	110	G2"	-	220	DN32 PN6	27.0
DGG 100/2/G50H A3AM5	254	110	525	110	G2"	-	220	DN32 PN6	28.0
DGG 100/2/G50H A3AT5	254	110	525	110	G2"	-	220	DN32 PN6	28.0
DGG 250/2/65 B0AT5	301	119	553	70	65	65	218	DN65 PN10-16	37.0
DGG 300/2/65 C0ET5	301	119	576	70	65	65	218	DN65 PN10-16	46.2
DGG 400/2/65 D0ET5	301	119	626	70	65	65	218	DN65 PN10-16	50.0
DGG 550/2/65 A0FT5	301	119	733	90	65	65	222	DN65 PN10-16	71.2
DGG 750/2/65 A0FT5	301	119	733	90	65	65	222	DN65 PN10-16	73.9
DGG 1000/2/65 A0FT5	301	119	808	90	65	65	222	DN65 PN10-16	81.8
DGG 250/2/80 F0AT5	312	120	580	80	80	80	236	DN80 PN10-16	35.0
DGG 300/2/80 G0ET5	312	120	602	80	80	80	236	DN80 PN10-16	44.2
DGG 400/2/80 H0ET5	312	120	652	80	80	80	236	DN80 PN10-16	47.0
DGG 550/2/80 N0FT5	313	125	762	92	80	80	251	DN80 PN10-16	71.6
DGG 750/2/80 A0FT5	313	125	762	92	80	80	251	DN80 PN10-16	74.3
DGG 1000/2/80 A0FT5	313	125	837	92	80	80	251	DN80 PN10-16	82.2
DGG 150/4/65 H0AT5	322	129	575	80	65	65	249	DN65 PN10-16	39.0
DGG 200/4/65 F0ET5	395	158	606	70	65	65	308	DN65 PN10-16	55.2
DGG 250/4/65 F0ET5	395	158	656	70	65	65	308	DN65 PN10-16	58.1
DGG 300/4/65 F0ET5	395	158	656	70	65	65	308	DN65 PN10-16	58.2
DGG 400/4/65 G0ET5	395	158	656	70	65	65	308	DN65 PN10-16	59.8
DGG 150/4/80 L0AT5	317	127	580	80	80	80	246	DN80 PN10-16	39.0
DGG 200/4/80 E0ET5	389	156	624	80	80	80	306	DN80 PN10-16	55.2
DGG 250/4/80 E0ET5	389	156	674	80	80	80	306	DN80 PN10-16	58.1

DGG

	A	B	C	D	E	E1	F		
DGG 300/4/80 E0ET5	389	156	674	80	80	80	306	DN80 PN10-16	58.2
DGG 400/4/80 M0ET5	389	156	674	80	80	80	306	DN80 PN10-16	59.8
DGG 550/4/80 D0FT5	484	194	820	80	80	80	374	DN80 PN10-16	97.0
DGG 750/4/80 D0FT5	484	194	820	80	80	80	374	DN80 PN10-16	97.2
DGG 1200/4/80 D0HT5	484	194	968	80	80	80	374	DN80 PN10-16	170.0
DGG 200/4/100 E0ET5	410	158	645	91	100	100	305	DN100 PN10-16	58.2
DGG 250/4/100 E0ET5	410	158	695	91	100	100	305	DN100 PN10-16	61.1
DGG 300/4/100 E0ET5	410	158	695	91	100	100	305	DN100 PN10-16	61.2
DGG 400/4/100 D0ET5	410	158	695	91	100	100	305	DN100 PN10-16	62.8
DGG 550/4/100 G0FT5	408	158	826	91	100	100	305	DN100 PN10-16	83.0
DGG 750/4/100 G0FT5	408	158	826	91	100	100	305	DN100 PN10-16	83.2
DGG 1200/4/100 B0HT5	496	190	1032	110	100	100	373	DN100 PN10-16	177.2
DGG 1500/4/100 B0HT5	496	190	1032	110	100	100	373	DN100 PN10-16	177.2
DGG 2000/4/100 B0HT5	496	190	1122	110	100	100	373	DN100 PN10-16	189.2
DGG 1200/4/150 A0HT5	612	222	985	130	150	150	447	DN150 PN10-16	212.0
DGG 1500/4/150 A0HT5	612	222	985	130	150	150	447	DN150 PN10-16	212.0
DGG 2000/4/150 A0HT5	612	222	1075	130	150	150	447	DN150 PN10-16	224.0



	X	Y	Z
DGG 75/2/G40V B3AM5	445	725	425
DGG 75/2/G40V B3AT5	445	725	425
DGG 100/2/G40V B3AM5	445	725	425
DGG 100/2/G40V B3AT5	445	725	425
DGG 150/2/G40V C3AM5	445	725	425
DGG 150/2/G40V C3AT5	445	725	425
DGG 250/2/G65V B0AT5	445	725	425
DGG 300/2/G65V C0ET5	445	725	425
DGG 75/2/G50H A3AM5	445	725	425
DGG 75/2/G50H A3AT5	445	725	425
DGG 100/2/G50H A3AM5	445	725	425
DGG 100/2/G50H A3AT5	445	725	425
DGG 250/2/65 B0AT5	445	725	425
DGG 300/2/65 C0ET5	445	725	425
DGG 400/2/65 D0ET5	445	725	425
DGG 550/2/65 A0FT5	535	915	560
DGG 750/2/65 A0FT5	535	915	560
DGG 1000/2/65 A0FT5	535	915	560
DGG 250/2/80 F0AT5	445	725	425
DGG 300/2/80 G0ET5	445	725	425
DGG 400/2/80 H0ET5	445	725	425
DGG 550/2/80 N0FT5	535	915	560
DGG 750/2/80 A0FT5	535	915	560
DGG 1000/2/80 A0FT5	535	915	560
DGG 150/4/65 H0AT5	445	725	425



	X	Y	Z
DGG 200/4/65 F0ET5	445	725	425
DGG 250/4/65 F0ET5	445	725	425
DGG 300/4/65 F0ET5	445	725	425
DGG 400/4/65 G0ET5	445	725	425
DGG 150/4/80 L0AT5	445	725	425
DGG 200/4/80 E0ET5	445	725	425
DGG 250/4/80 E0ET5	445	725	425
DGG 300/4/80 E0ET5	445	725	425
DGG 400/4/80 M0ET5	445	725	425
DGG 550/4/80 D0FT5	535	915	560
DGG 750/4/80 D0FT5	535	915	560
DGG 1200/4/80 D0HT5	535	1000	560
DGG 200/4/100 E0ET5	445	725	425
DGG 250/4/100 E0ET5	445	725	425
DGG 300/4/100 E0ET5	445	725	425
DGG 400/4/100 D0ET5	445	725	425
DGG 550/4/100 G0FT5	535	915	560
DGG 750/4/100 G0FT5	535	915	560
DGG 1200/4/100 B0HT5	725	1270	675
DGG 1500/4/100 B0HT5	725	1270	675
DGG 2000/4/100 B0HT5	725	1270	675
DGG 1200/4/150 A0HT5	725	1270	675
DGG 1500/4/150 A0HT5	725	1270	675
DGG 2000/4/150 A0HT5	725	1270	675

Погружные электронасосы с многоканальной открытой крыльчаткой

Сферы применения

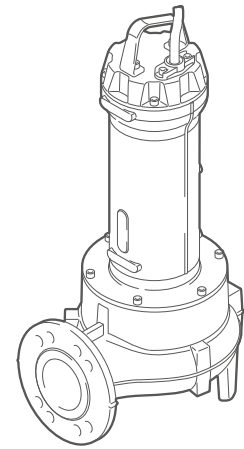
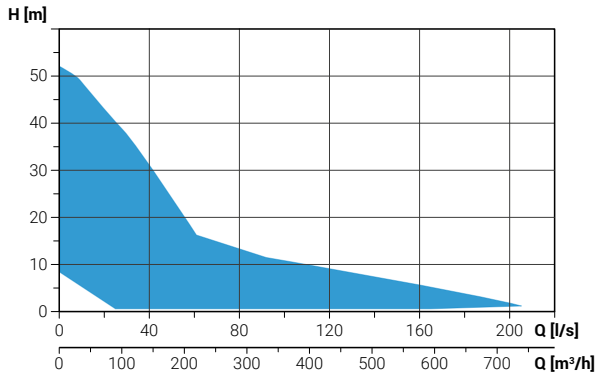

Общие характеристики

Мощность	1.8 ÷ 18.5 kW
Кол. полюсов	2 / 4 / 6
Класс изоляции	H
Коэффициент защиты	IP68
Направление вертикальный	G 2½"
Направление горизонтальный	DN65 ÷ DN250
Свободный просвет	max 100 x 70 mm
Макс. производительность	205.0 l/s
Макс. напор	50.0 m

Доступные версии

Электрические варианты	NAE, TS
Система охлаждения	N
Механические уплотнения	2SiC

Ограничения по эксплуатации

Макс. температура эксплуатации	40 °C
РН обработанной жидкости	6 ÷ 14
Вязкость обработанной жидкости	1 mm²/s
Макс. глубина погружения	20 m
Плотность обработанной жидкости	1 Kg/dm³
Макс. акустическое давление	<70dB
Макс. запусков/час	30

Двигатель

Экологический сухой двигатель с тепловой защитой.

Кабель

Кабель S1RN8-F 10 m (стандартная версия)

Механические уплотнения

Два механических уплотнения из карбида кремния (2SiC), оба устанавливаемых в камере с маслом

Назначение оборудования

Разработан в основном для профессионального и промышленного использования, такого как очистка вод, канализационные системы и животноводческие фермы. Особенно пригоден для обработки жидкостей, содержащих твердые взвешенные тела, активный шлам с низкой или средней плотностью.

Установка

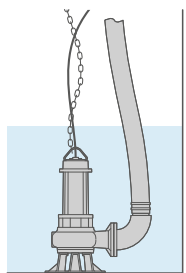

Свободная установка

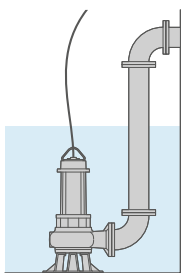

Фиксированная установка

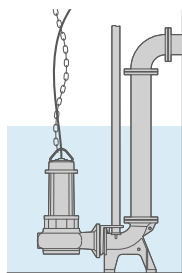

Установка с донным соединительным устройством

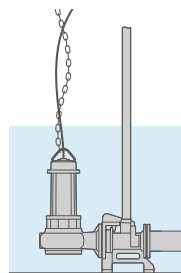

Установка с донным соединительным устройством

Материалы для изготовления

Каркас	Чугун EN-GJL 250
Гидравлическая часть	Чугун EN-GJL 250
Материал крыльчатки	Чугун EN-GJL 250
Крепеж	Нержавеющая сталь - Класс A2-70
Стандартное уплотнение	Резина - NBR
Вал	Нержавеющая сталь - AISI 431
Окраска	Эпоксидная, двухкомпонентная, на водной основе (средняя толщина ~200 мкм)
Системы измельчения	-
Всасывающая решетка	-



DRG 75÷100/2/G40V

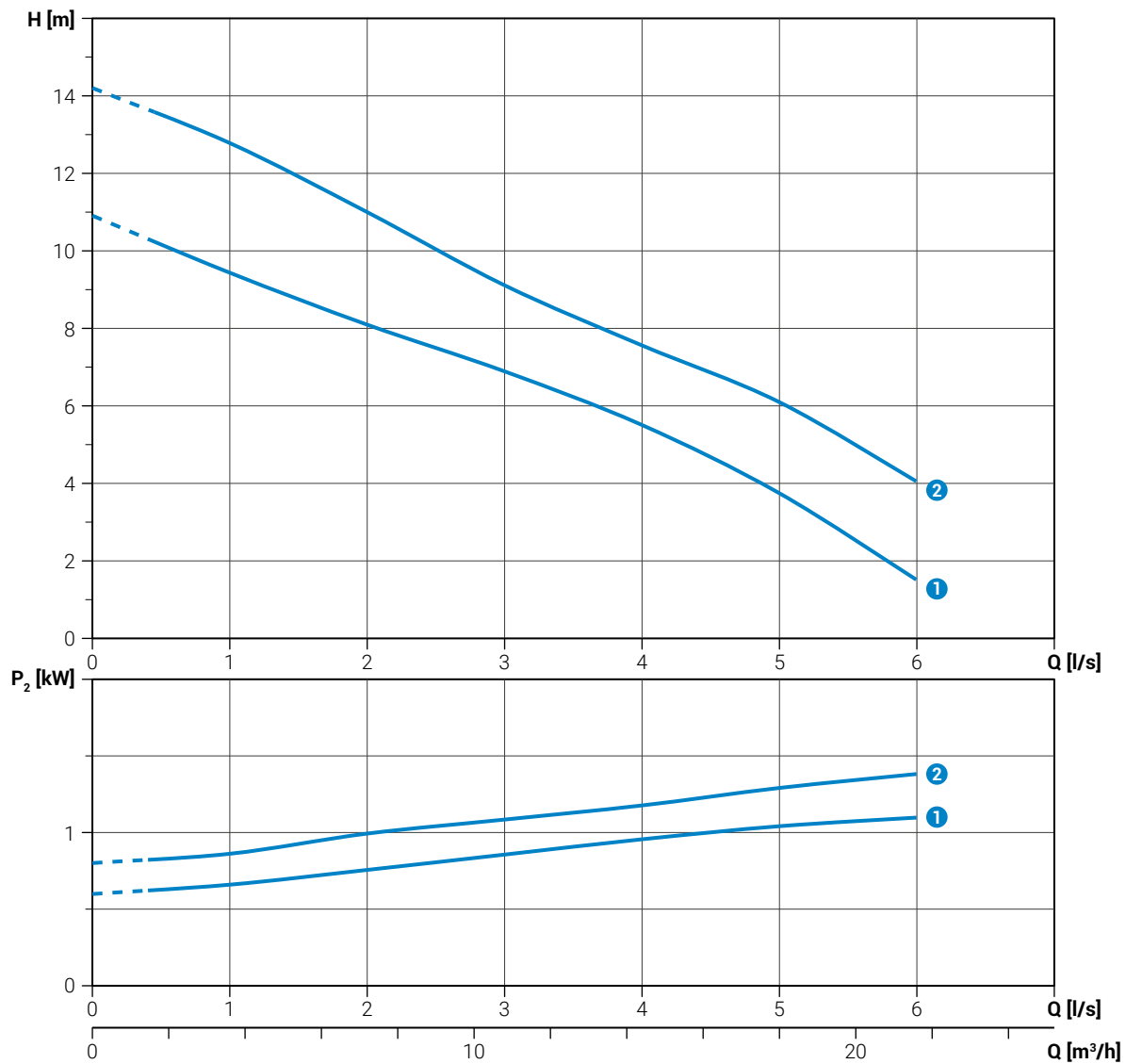

Характеристики

	l/s	0	1	2	3	4	5	6
	l/min	0	60	120	180	240	300	360
	m ³ /h	0	3.6	7.2	10.8	14.4	18	21.6
1	DRG 75/2/G40V A3AM5	10.9	9.4	8.1	6.9	5.5	3.8	1.5
	DRG 75/2/G40V A3AT5							
2	DRG 100/2/G40V A3AM5	14.2	12.8	11.0	9.1	7.6	6.1	4.1
	DRG 100/2/G40V A3AT5							



Диапазоны мощности соответствуют нормативу UNI EN ISO 9906

Технические данные

	V	1~ 3~	P ₁ [kW]	P ₂ [kW]	A	Rpm	DOL Y/Δ				
1	DRG 75/2/G40V A3AM5	400	1~	0.8	0.6	4.2	2900	-	4G1.5+3x1	G1 ¹ / ₂	15x10 mm
	DRG 75/2/G40V A3AT5	400	3~	0.7	0.6	1.4	2900	DOL	4G1.5+3x1	G1 ¹ / ₂	15x10 mm
2	DRG 100/2/G40V A3AM5	400	1~	1.0	0.8	4.9	2900	-	4G1.5+3x1	G1 ¹ / ₂	15x10 mm
	DRG 100/2/G40V A3AT5	400	3~	0.9	0.8	1.7	2900	DOL	4G1.5+3x1	G1 ¹ / ₂	15x10 mm

**DRG 150÷200/2/G50V****Характеристики**

l/s	0	2	4	6	8	10	12
l/min	0	120	240	360	480	600	720
m ³ /h	0	7.2	14.4	21.6	28.8	36	43.2

1	DRG 150/2/G50V A3AM5	13.3	12.5	11.3	9.4	6.6	3.0
	DRG 150/2/G50V A3AT5						
2	DRG 200/2/G50V A3AM5	17.0	16.1	15.0	13.2	10.4	6.8
	DRG 200/2/G50V A3AT5						2.3

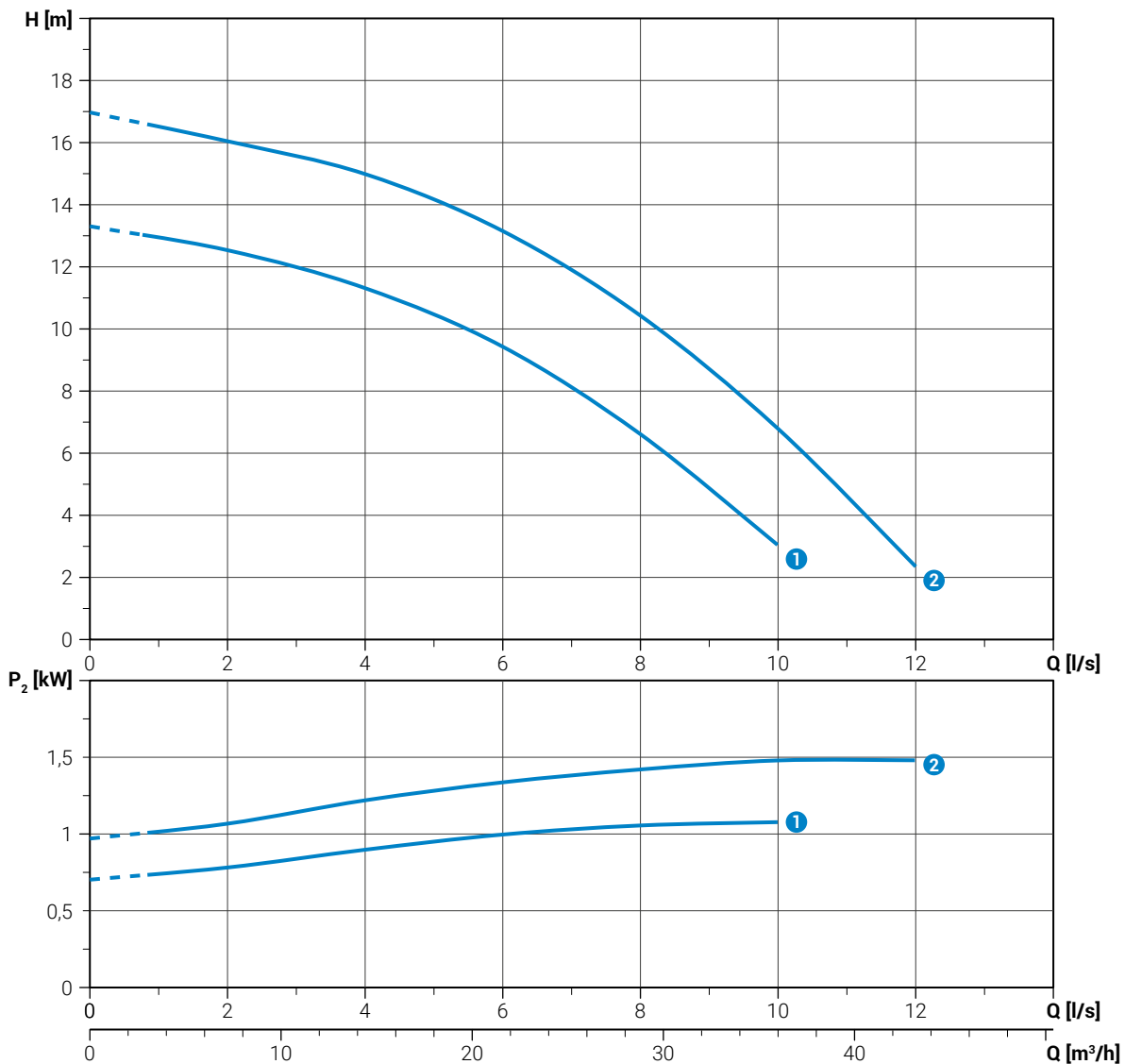

Диапазоны мощности соответствуют нормативу UNI EN ISO 9906

Технические данные

	V	1~ 3~	P ₁ [kW]	P ₂ [kW]	A	Rpm	DOL Y/Δ				
1	DRG 150/2/G50V A3AM5	400	1~	1.38	1.1	6.6	2900	-	4G1.5+3x1	G2"	15x10 mm
2	DRG 150/2/G50V A3AT5	400	3~	1.33	1.1	2.4	2900	DOL	4G1.5+3x1	G2"	15x10 mm
3	DRG 200/2/G50V A3AM5	400	1~	1.98	1.5	9.3	2900	-	4G1.5+3x1	G2"	15x10 mm
4	DRG 200/2/G50V A3AT5	400	3~	1.78	1.5	3.3	2900	DOL	4G1.5+3x1	G2"	15x10 mm

DRG 250÷400/2/G65V

Характеристики

	l/s	0	4	8	12	16	20	24
	l/min	0	240	480	720	960	1200	1440
	m ³ /h	0	14.4	28.8	43.2	57.6	72.0	86.4
① DRG 250/2/G65V B0AT5		17.6	13.9	11.3	8.9	6.1	3.6	
② DRG 300/2/G65V A0ET5		20.0	16.3	13.8	10.9	8.1	5.7	
③ DRG 400/2/G65V A0ET5		24.6	20.7	17.8	15.0	11.9	9.1	6.4

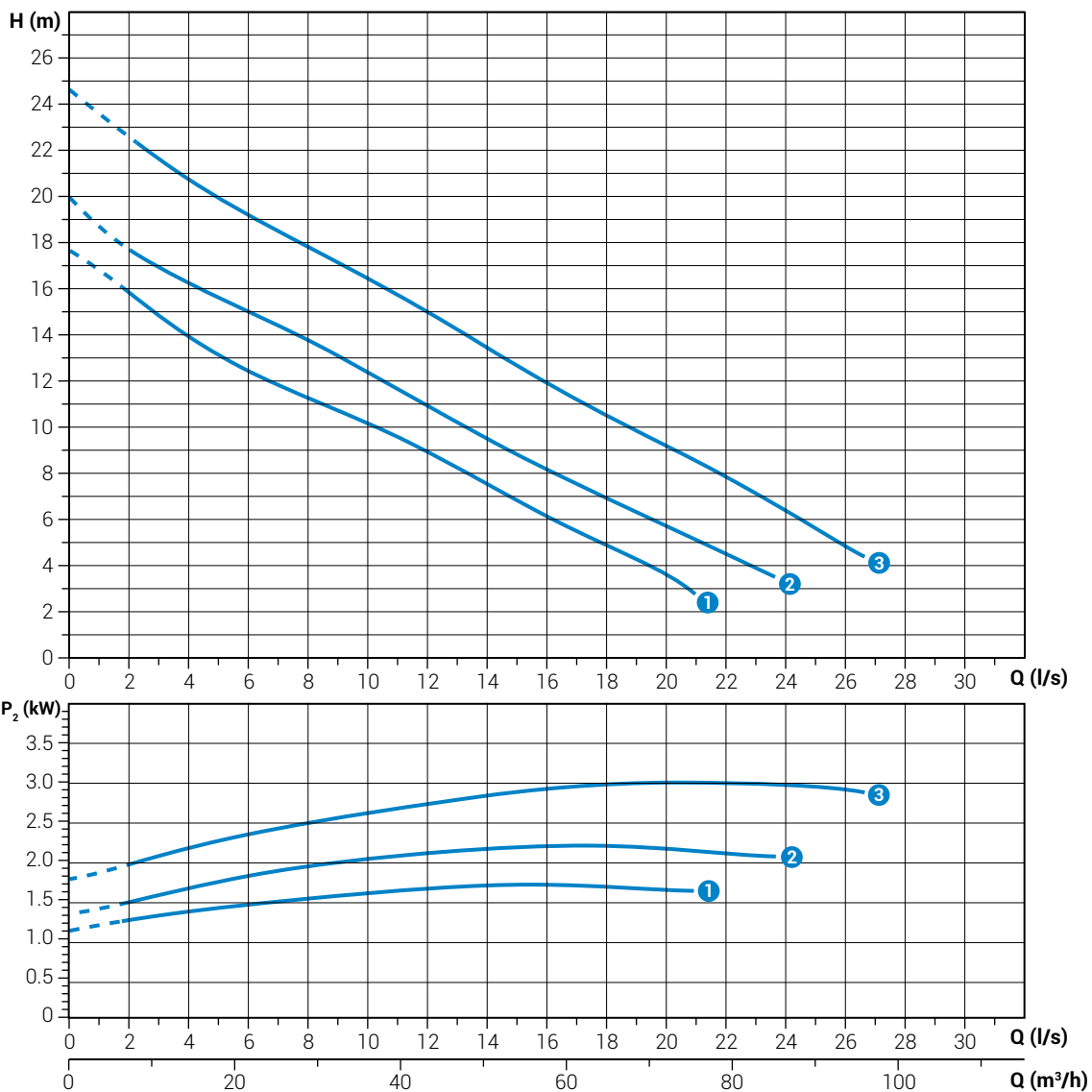

Диапазоны мощностей соответствуют нормативу UNI EN ISO 9906

Технические данные

	V	1~ 3~	P ₁ [kW]	P ₂ [kW]	A	Rpm	DOL Y/Δ			
① DRG 250/2/G65V B0AT5	400	3~	2.2	1.8	3.7	2900	DOL	4G1	G2½"	35x30 mm
② DRG 300/2/G65V A0ET5	400	3~	2.8	2.2	4.6	2900	DOL	4G1.5+3x1	G2½"	40x35 mm
③ DRG 400/2/G65V A0ET5	400	3~	3.7	3.0	6.4	2900	DOL	4G1.5+3x1	G2½"	40x35 mm

**DRG 75÷100/2/G40H****Характеристики**

	l/s	0	1	2	3	4	5	6	7	8
	l/min	0	60	120	180	240	300	360	420	480
	m ³ /h	0	3.6	7.2	10.8	14.4	18	21.6	25.2	28.8
1	DRG 75/2/G40H A3AM5	11.1	9.5	8.6	7.6	6.5	5.3	3.8		
	DRG 75/2/G40H A3AT5									
2	DRG 100/2/G40H A3AM5	14.0	12.3	10.9	9.8	8.8	7.6	6.2	4.4	2.3
	DRG 100/2/G40H A3AT5									

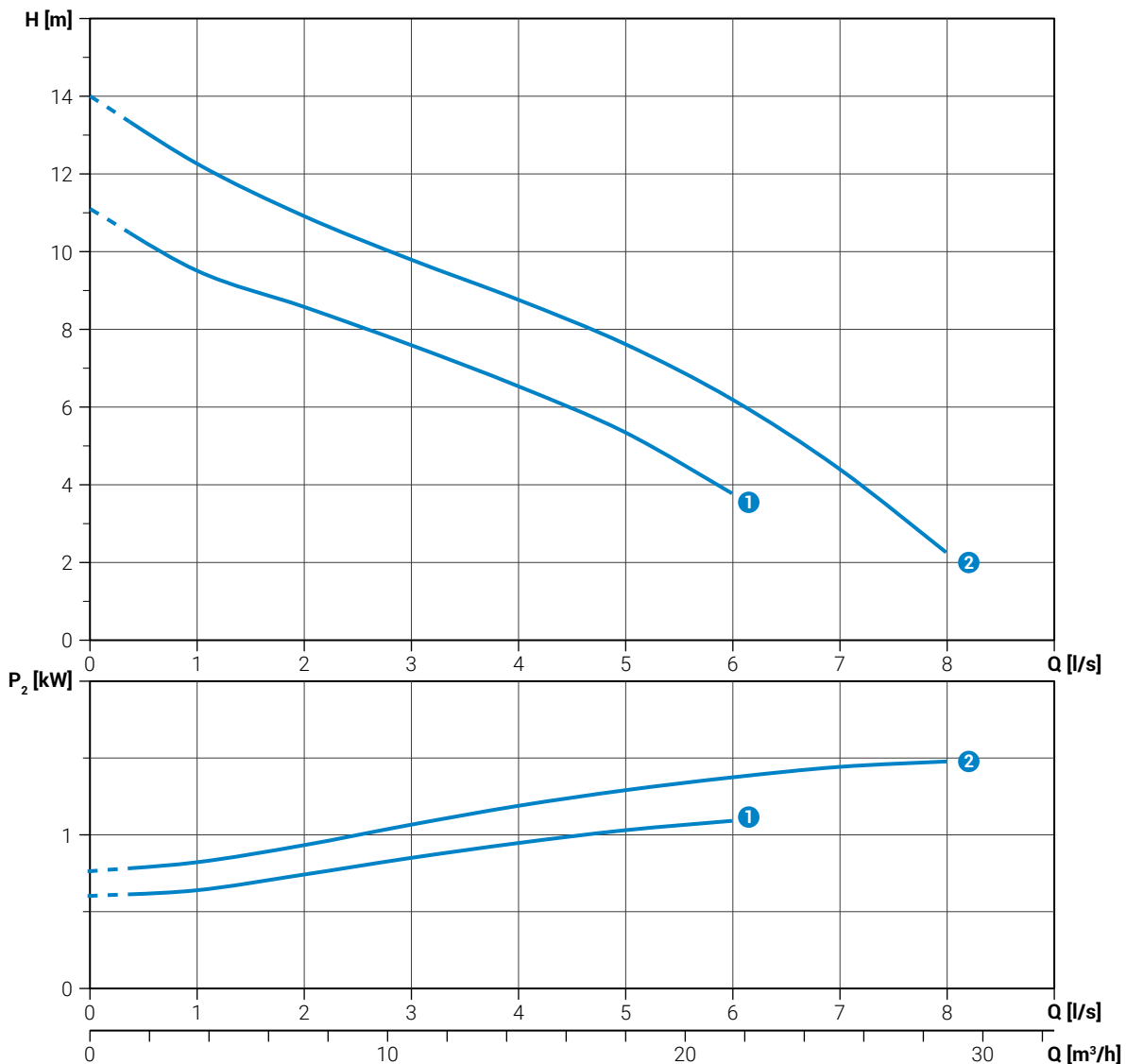

Диапазоны мощности соответствуют нормативу UNI EN ISO 9906

Технические данные

	V	1~ 3~	P ₁ [kW]	P ₂ [kW]	A	Rpm	DOL Y/Δ				
1	DRG 75/2/G40H A3AM5	400	1~	0.8	0.6	4.2	2900	-	4G1.5+3x1	G1"½ DN32	15x10 mm
	DRG 75/2/G40H A3AT5	400	3~	0.7	0.6	1.4	2900	DOL	4G1.5+3x1	G1"½ DN32	15x10 mm
2	DRG 100/2/G40H A3AM5	400	1~	1.0	0.8	4.9	2900	-	4G1.5+3x1	G1"½ DN32	15x10 mm
	DRG 100/2/G40H A3AT5	400	3~	0.9	0.8	1.7	2900	DOL	4G1.5+3x1	G1"½ DN32	15x10 mm

DRG 150÷200/2/G50H

Характеристики

	l/s	0	2	4	6	8	10	12
	l/min	0	120	240	360	480	600	720
	m ³ /h	0	7.2	14.4	21.6	28.8	36	43.2
<hr/>								
1	DRG 150/2/G50H A3AM5	13.3	12.6	11.5	9.9	7.5	4.1	
	DRG 150/2/G50H A3AT5							
<hr/>								
2	DRG 200/2/G50H A3AM5	17.4	16.5	15.5	13.8	11.3	8.2	4.2
	DRG 200/2/G50H A3AT5							

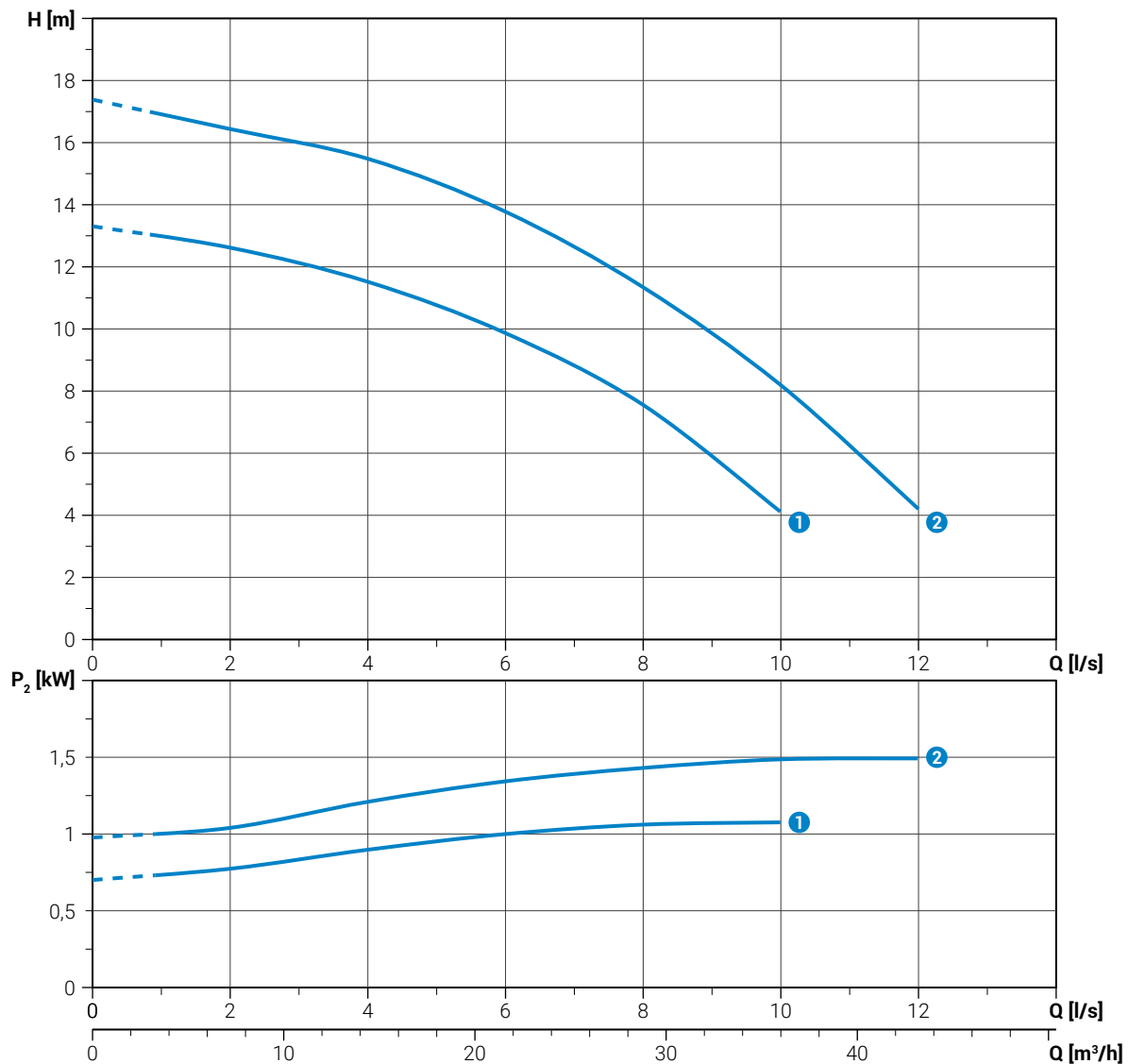

Диапазоны мощности соответствуют нормативу UNI EN ISO 9906

Технические данные

	V	1~ 3~	P ₁ [kW]	P ₂ [kW]	A	Rpm	DOL Y/Δ				
1	DRG 150/2/G50H A3AM5	400	1~	1.4	1.1	6.6	2900	-	4G1.5+3x1	G2"	15x10 mm
	DRG 150/2/G50H A3AT5	400	3~	1.3	1.1	2.4	2900	DOL	4G1.5+3x1	G2"	15x10 mm
2	DRG 200/2/G50H A3AM5	400	1~	2.0	1.5	9.3	2900	-	4G1.5+3x1	G2"	15x10 mm
	DRG 200/2/G50H A3AT5	400	3~	1.8	1.5	3.3	2900	DOL	4G1.5+3x1	G2"	15x10 mm

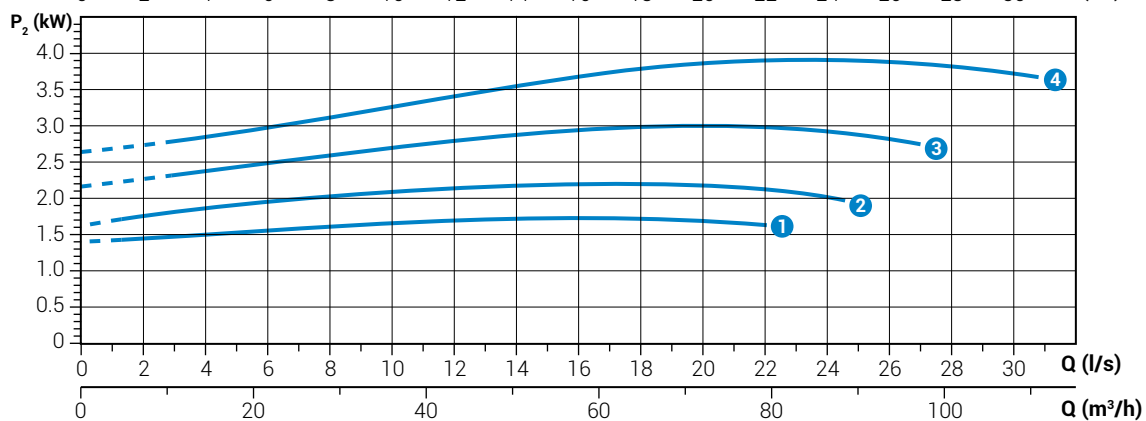
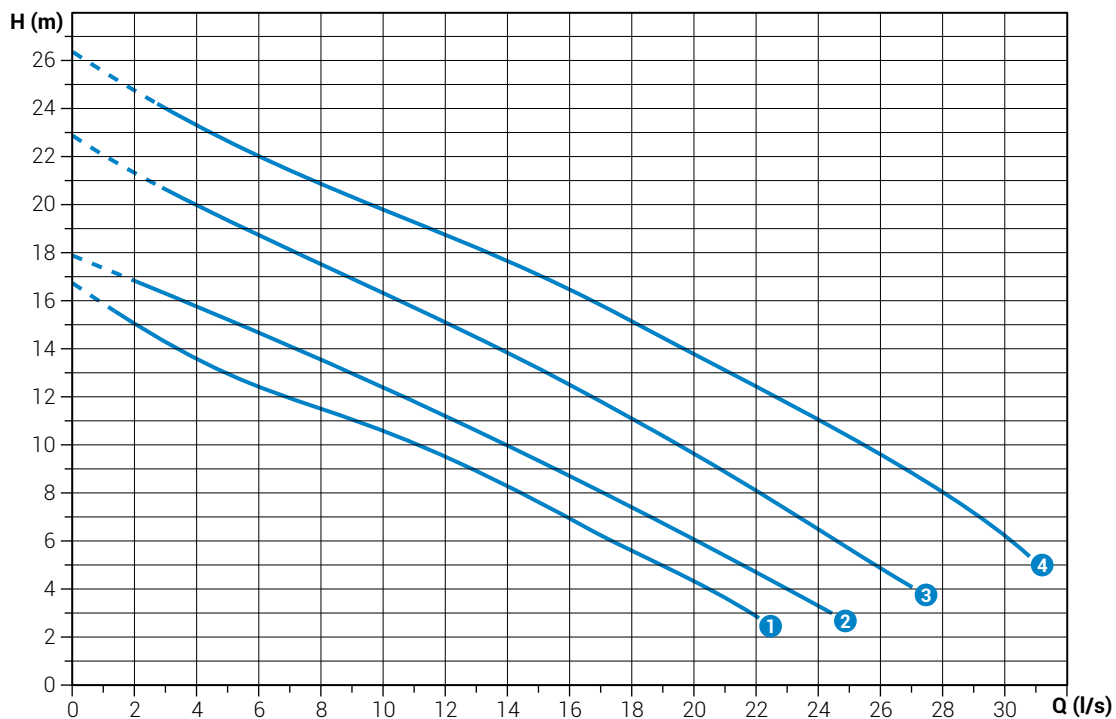

**DRG 250÷550/2/65****Характеристики**

	l/s	0	4	8	12	16	20	24	28
	l/min	0	240	480	720	960	1200	1440	1680
	m ³ /h	0	14.4	28.8	43.2	57.6	72.0	86.4	100.8
1	DRG 250/2/65 B0AT5	16.7	13.5	11.4	9.5	6.9	4.3		
2	DRG 300/2/65 A0ET5	17.9	15.8	13.6	11.2	8.7	6.1	3.3	
3	DRG 400/2/65 A0ET5	22.8	19.9	17.5	15.0	12.5	9.6	6.5	
4	DRG 550/2/65 C0FT5	26.4	23.3	20.9	18.8	16.5	13.9	11.1	8.1



Диапазоны мощности соответствуют нормативу UNI EN ISO 9906

Технические данные

	V	1~ 3~	P ₁ [kW]	P ₂ [kW]	A	Rpm	DOL Y/Δ			
1	400	3~	2.2	1.8	3.7	2900	DOL	4G1	DN65	35x30 mm
2	400	3~	2.8	2.2	4.6	2900	DOL	4G1.5+3x1	DN65	40x35 mm
3	400	3~	3.7	3.0	6.4	2900	DOL	4G1.5+3x1	DN65	40x35 mm
4	400	3~	4.7	4.0	7.7	2900	DOL	4G1.5+3x1	DN65	40x35 mm

DRG 150÷550/2/80

Характеристики

	l/s	0	4	8	12	16	20	24	28
	l/min	0	240	480	720	960	1200	1440	1680
	m ³ /h	0	14.4	28.8	43.2	57.6	72	86.4	100.8
1	DRG 150/2/80 LOAT5	11.8	9.6	7.5	5.6	2.9			
2	DRG 200/2/80 LOAT5	16.1	13.0	10.5	8.1	5.3	2.4		
3	DRG 250/2/80 LOAT5	17.0	13.4	11.3	9.2	6.6	4.0	1.3	
4	DRG 300/2/80 E0ET5	18.4	15.9	13.6	11.4	9.1	6.9	4.7	
5	DRG 400/2/80 E0ET5	23.5	20.3	17.7	15.1	12.4	9.6	6.6	3.8
6	DRG 550/2/80 POFT5	26.2	23.3	20.8	18.5	16.1	13.3	10.3	7.0

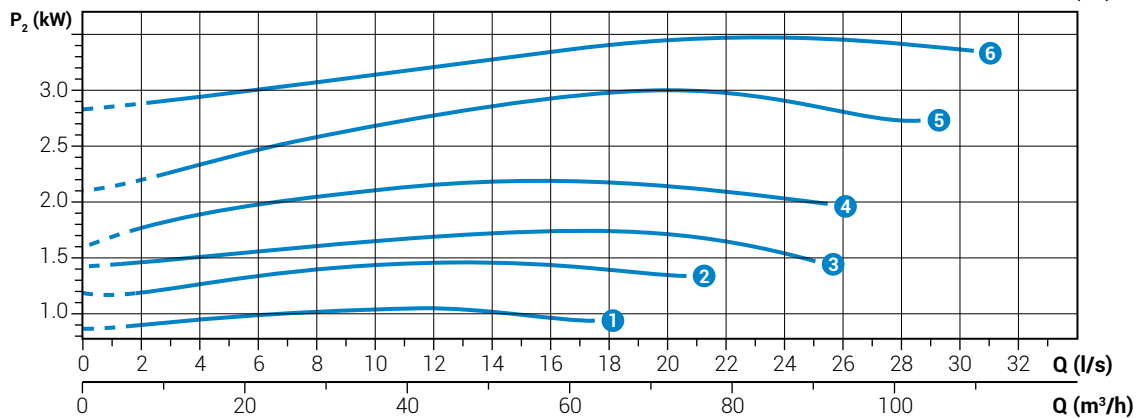
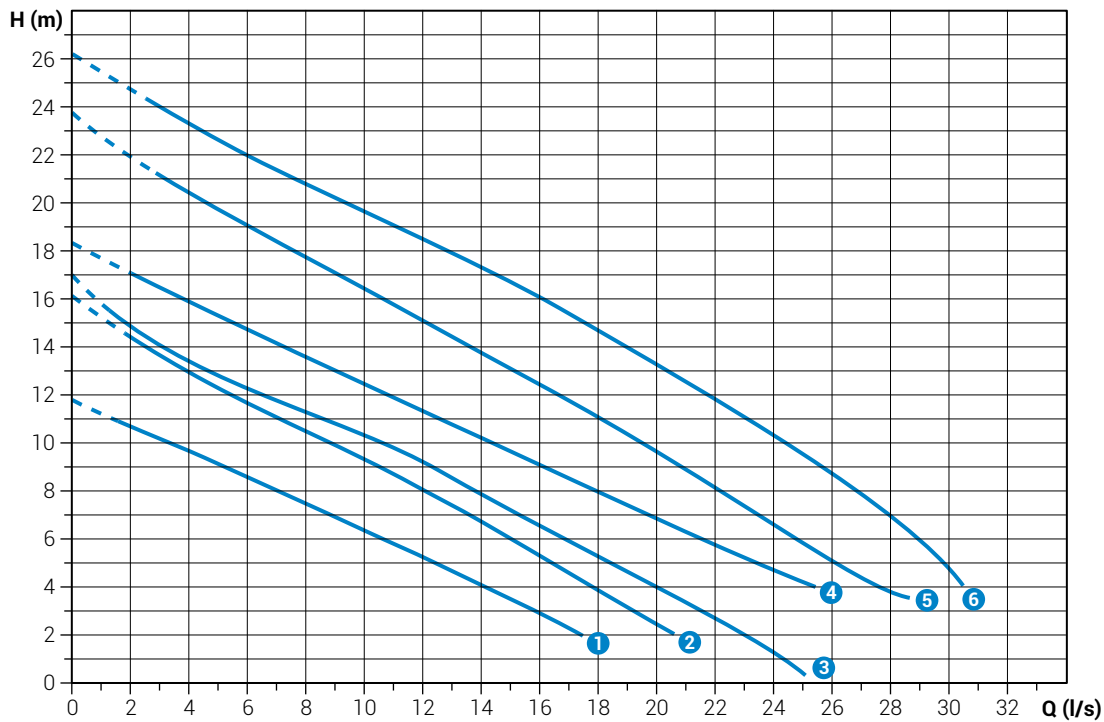

Технические данные

	V	1~ 3~	P ₁ [kW]	P ₂ [kW]	A	Rpm	DOL Y/Δ				
1	DRG 150/2/80 LOAT5	400	3~	1.33	1.1	2.4	2900	DOL	4G1	DN80	35x30 mm
2	DRG 200/2/80 LOAT5	400	3~	1.78	1.5	3.3	2900	DOL	4G1	DN80	35x30 mm
3	DRG 250/2/80 LOAT5	400	3~	2.2	1.8	3.7	2900	DOL	4G1	DN80	35x30 mm
4	DRG 300/2/80 E0ET5	400	3~	2.8	2.2	4.6	2900	DOL	4G1.5+3x1	DN80	40x35 mm
5	DRG 400/2/80 E0ET5	400	3~	3.7	3.0	6.4	2900	DOL	4G1.5+3x1	DN80	40x35 mm
6	DRG 550/2/80 POFT5	400	3~	4.7	4.0	7.7	2900	DOL	4G1.5+3x1	DN80	40x35 mm

Диапазоны мощностей соответствуют нормативу UNI EN ISO 9906

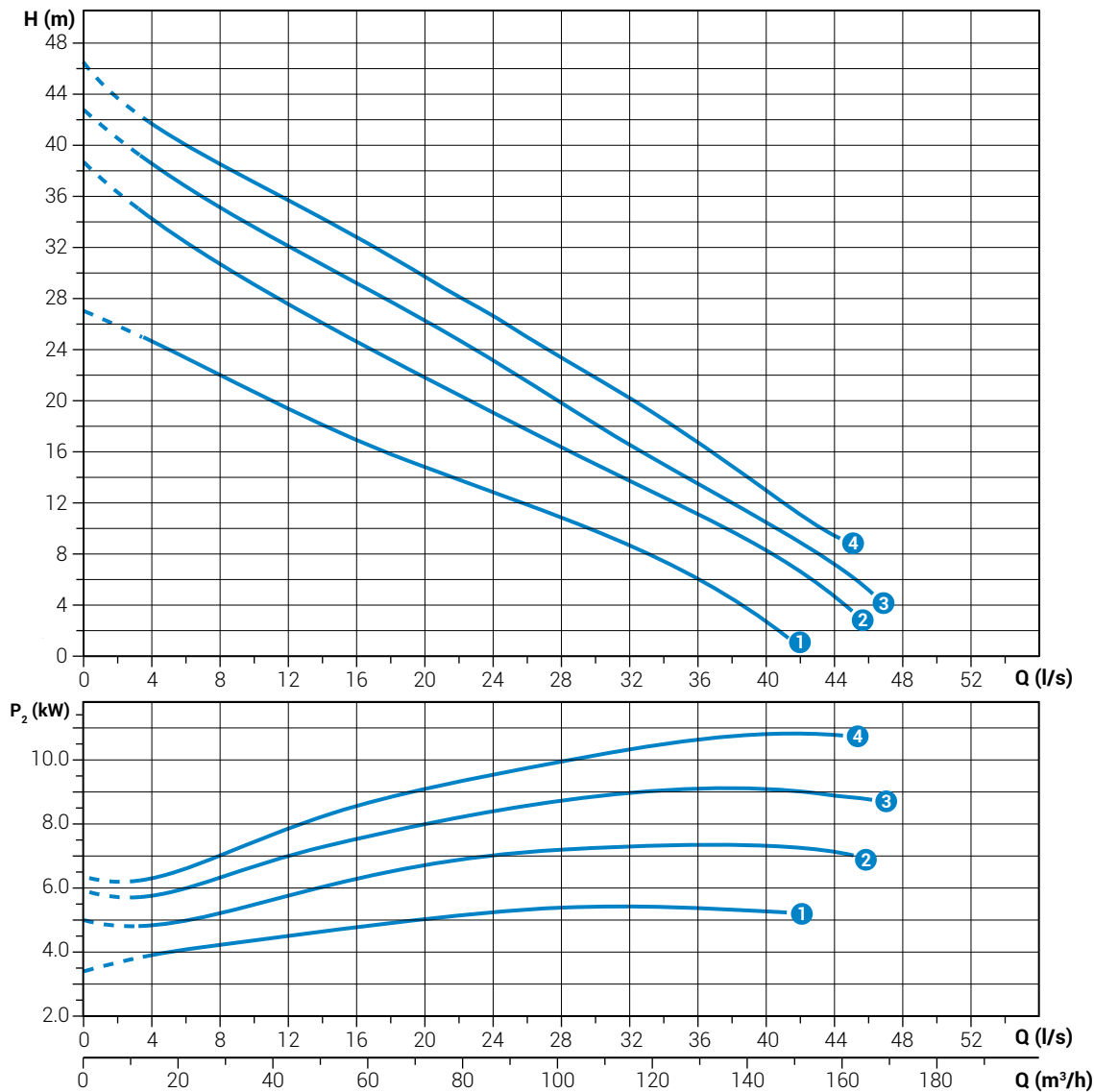

**DRG 750÷1500/2/80 A****Характеристики**

	l/s	0	4	8	12	16	20	24	28	32	36	40	44
	l/min	0	240	480	720	960	1200	1440	1680	1920	2160	2400	2640
	m ³ /h	0	14.4	28.8	43.2	57.6	72	86.4	100.8	115.2	129.6	144	158.4
1	DRG 750/2/80 A0FT5	27.0	24.7	22.0	19.3	16.9	14.7	12.8	10.8	8.6	6.0	2.6	
2	DRG 1000/2/80 A0FT5	38.6	34.2	30.6	27.6	24.7	21.8	19.0	16.3	13.7	11.1	8.3	4.7
3	DRG 1200/2/80 A0GT5	42.8	38.6	35.1	32.1	29.3	26.4	23.2	19.9	16.6	13.4	10.5	7.2
4	DRG 1500/2/80 A0GT5	46.5	41.5	38.5	35.7	32.8	29.6	24.5	23.4	20.2	16.7	13.0	9.5



Диапазоны мощности соответствуют нормативу UNI EN ISO 9906

Технические данные

	V	1~ 3~	P ₁ [kW]	P ₂ [kW]	A	Rpm	DOL Y/Δ			
1	400	3~	6.3	5.5	10.8	2900	DOL	4G1.5+3x1	DN80	40 mm
2	400	3~	8.5	7.5	13.7	2900	DOL	4G1.5+3x1	DN80	40 mm
3	400	3~	10.4	9.0	16.1	2900	Y/Δ	7G1.5+3x1	DN80	40 mm
4	400	3~	12.6	11.0	19.5	2900	Y/Δ	7G1.5+3x1	DN80	40 mm



DRG 550÷1500/2/80 B

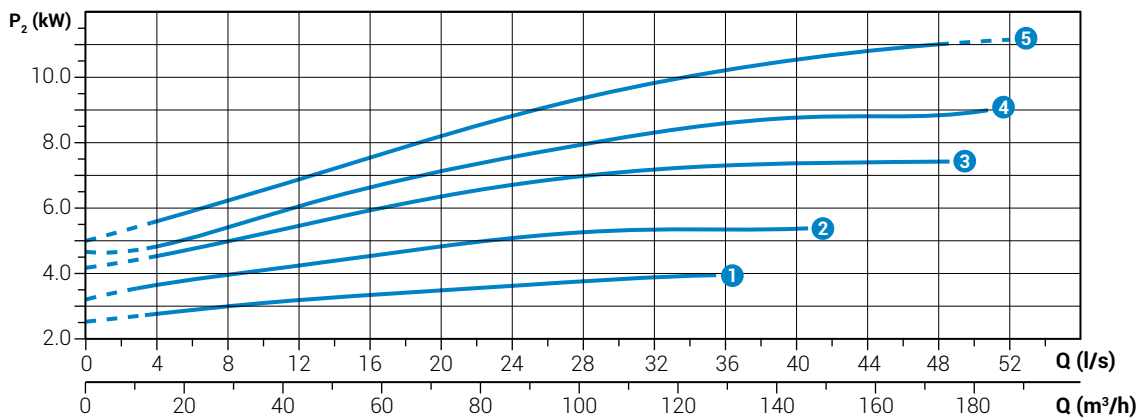
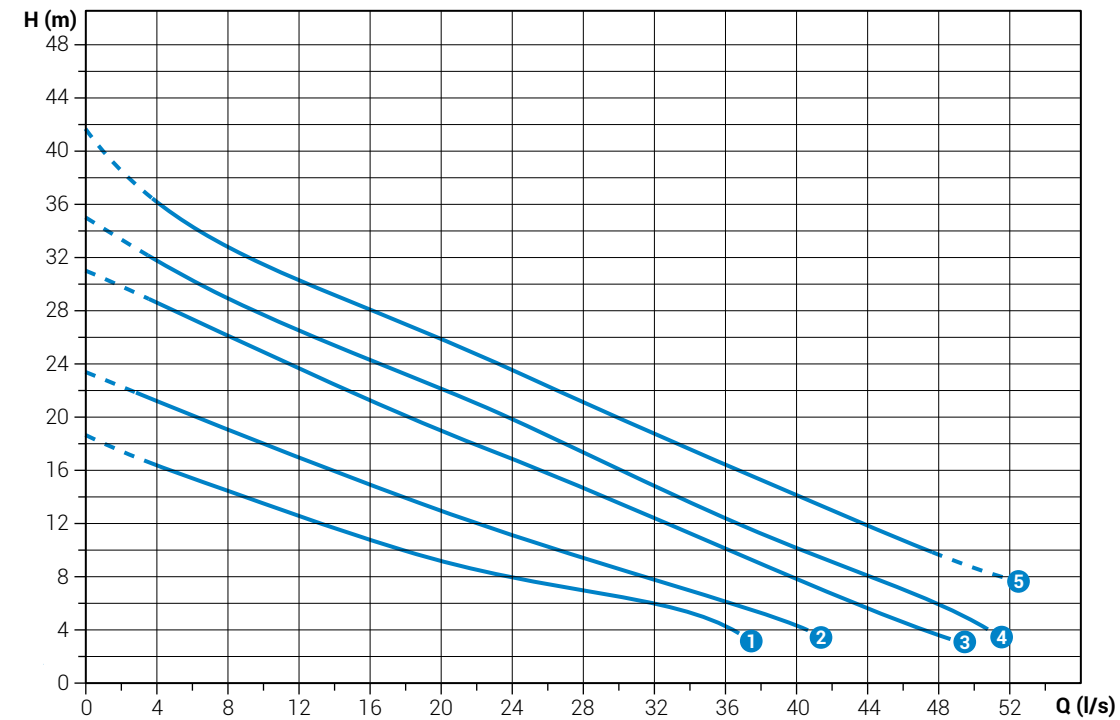

Характеристики

	l/s	0	4	8	12	16	20	24	28	32	36	40	44	48
	l/min	0	240	480	720	960	1200	1440	1680	1920	2160	2400	2640	2880
	m³/h	0	14.4	28.8	43.2	57.6	72	86.4	100.8	115.2	129.6	144	158.4	172.8
① DRG 550/2/80 B0FT5		18.6	16.3	14.4	12.5	10.7	9.1	7.9	6.9	5.9	4.2			
② DRG 750/2/80 B0FT5		23.4	21.3	19.1	17.0	14.9	13.0	11.1	9.4	7.8	6.1	4.3		
③ DRG 1000/2/80 B0FT5		30.9	28.5	26.0	23.6	21.2	19.0	16.8	14.6	12.4	10.2	7.8	5.6	3.6
④ DRG 1200/2/80 B0GT5		35.0	31.7	28.9	26.5	24.3	22.1	19.8	17.4	14.8	12.4	10.2	8.1	5.9
⑤ DRG 1500/2/80 B0GT5		41.7	36.1	32.8	30.4	28.2	25.9	23.5	21.1	18.8	16.5	14.2	11.9	



Диапазоны мощностей соответствуют нормативу UNI EN ISO 9906

Технические данные

	V	1~ 3~	P ₁ [kW]	P ₂ [kW]	A	Rpm	DOL Y/Δ			
① DRG 550/2/80 B0FT5	400	3~	4.7	4.0	7.7	2900	DOL	4G1.5+3x1	DN80	55x50 mm
② DRG 750/2/80 B0FT5	400	3~	6.3	5.5	10.8	2900	DOL	4G1.5+3x1	DN80	50x55 mm
③ DRG 1000/2/80 B0FT5	400	3~	8.5	7.5	13.7	2900	DOL	4G1.5+3x1	DN80	50x55 mm
④ DRG 1200/2/80 B0GT5	400	3~	10.4	9.0	16.1	2900	Y/Δ	7G1.5+3x1	DN80	40 mm
⑤ DRG 1500/2/80 B0GT5	400	3~	12.6	11.0	19.5	2900	Y/Δ	7G1.5+3x1	DN80	40 mm

**DRG 2000÷2500/2/80 G****Характеристики**

	l/s	0	4	8	12	16	20	24	28	32	36	40	44	48
	l/min	0	240	480	720	960	1200	1440	1680	1920	2160	2400	2640	2880
	m ³ /h	0	14.4	28.8	43.2	57.6	72	86.4	100.8	115.2	129.6	144	158.4	172.8
①	DRG 2000/2/80 G0HT5	45.0	41.6	38.1	35.0	32.3	29.9	27.6	25.2	22.6	20.0	17.5	14.9	
②	DRG 2500/2/80 G0HT5	48.3	46.0	42.7	39.5	36.8	34.3	32.0	29.5	27.0	24.3	21.7	19.0	15.6

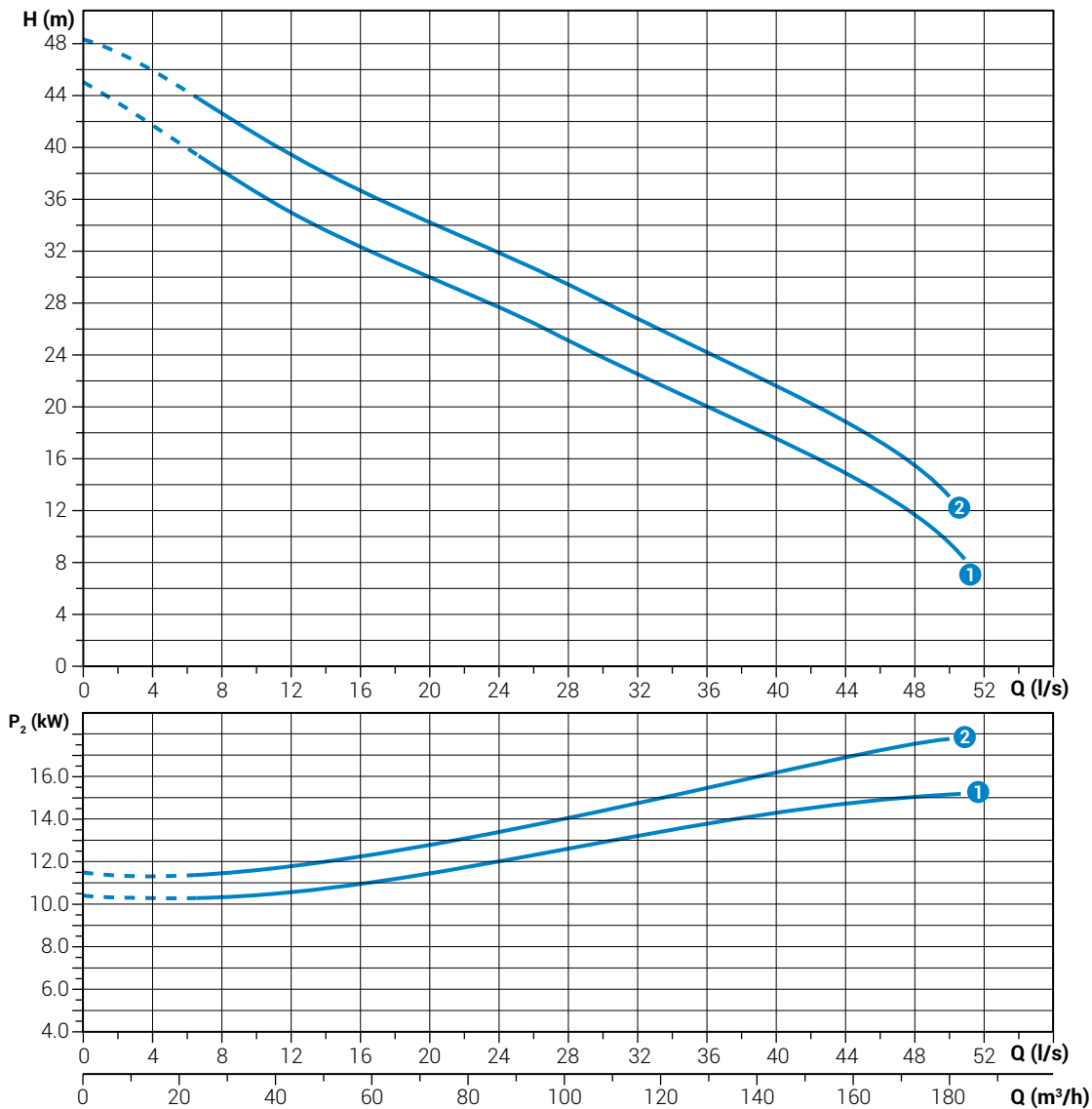

Диапазоны мощности соответствуют нормативу UNI EN ISO 9906

Технические данные

	V	1~ 3~	P ₁ [kW]	P ₂ [kW]	A	Rpm	DOL Y/Δ				
①	DRG 2000/2/80 G0HT5	400	3~	16.9	15.0	26.2	2900	Y/Δ	7G1.5+3x1	DN80	75 mm
②	DRG 2500/2/80 G0HT5	400	3~	20.7	18.5	32.9	2900	Y/Δ	7G2.5+3x1	DN80	75 mm



DRG 2000÷2500/2/80 W

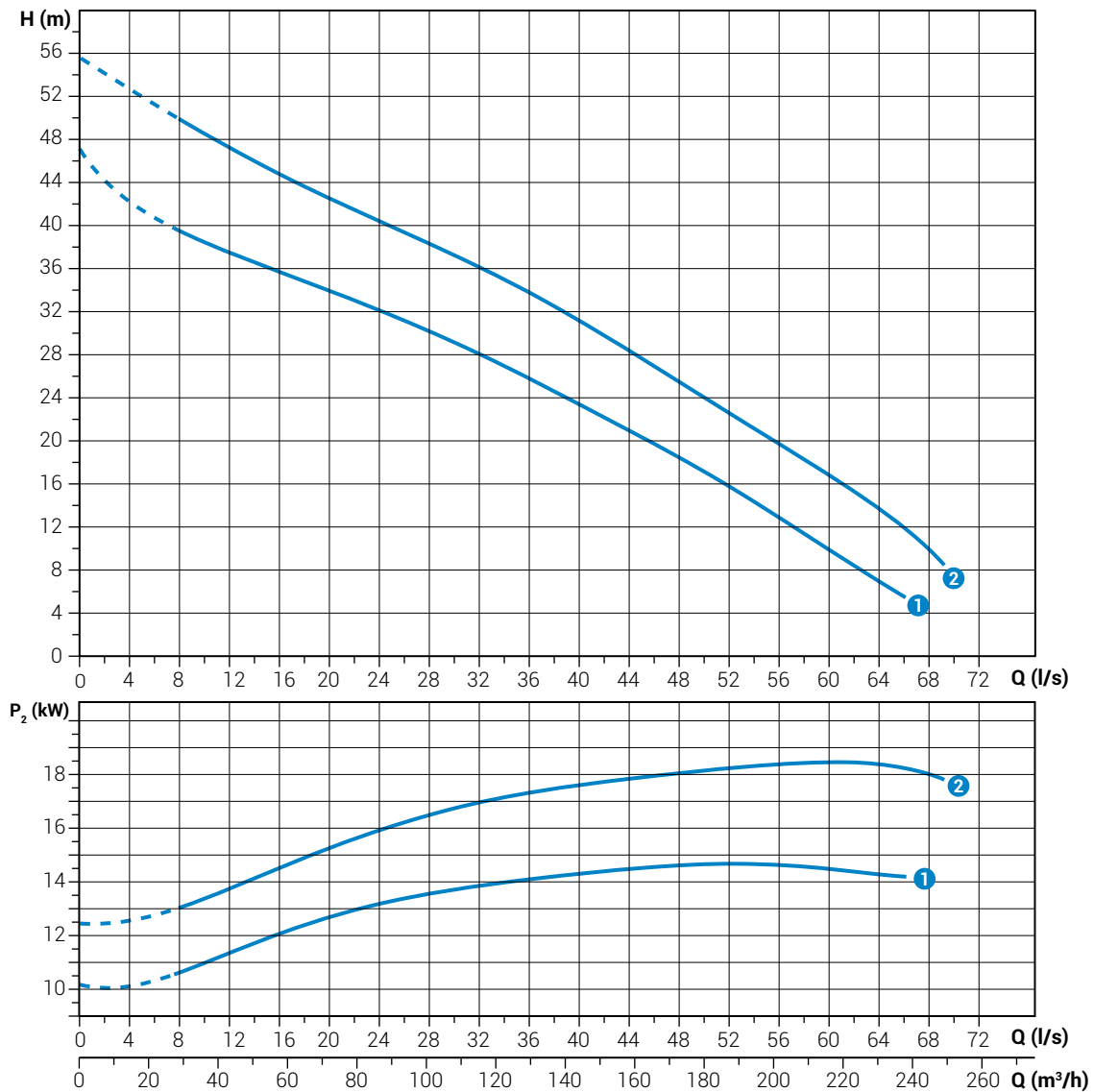

Характеристики

	l/s	0	8	16	24	32	40	48	56	64
	l/min	0	480	960	1440	1920	2400	2880	3360	3840
	m ³ /h	0	28.8	57.6	86.4	115.2	144	172.8	201.6	230.4
①	DRG 2000/2/80 W0HT5	46.7	39.4	35.7	32.1	28.0	23.4	18.5	12.9	6.9
②	DRG 2500/2/80 W0HT5	55.5	49.9	44.7	40.4	36.1	31.1	25.5	19.7	13.7



Диапазоны мощности соответствуют нормативу UNI EN ISO 9906

Технические данные

	V	1~ 3~	P ₁ [kW]	P ₂ [kW]	A	Rpm	DOL Y/Δ				
①	DRG 2000/2/80 W0HT5	400	3~	16.9	15.0	26.2	2900	Y/Δ	7G1.5+3x1	DN80	45 mm
②	DRG 2500/2/80 W0HT5	400	3~	20.7	18.5	32.9	2900	Y/Δ	7G2.5+3x1	DN80	45 mm

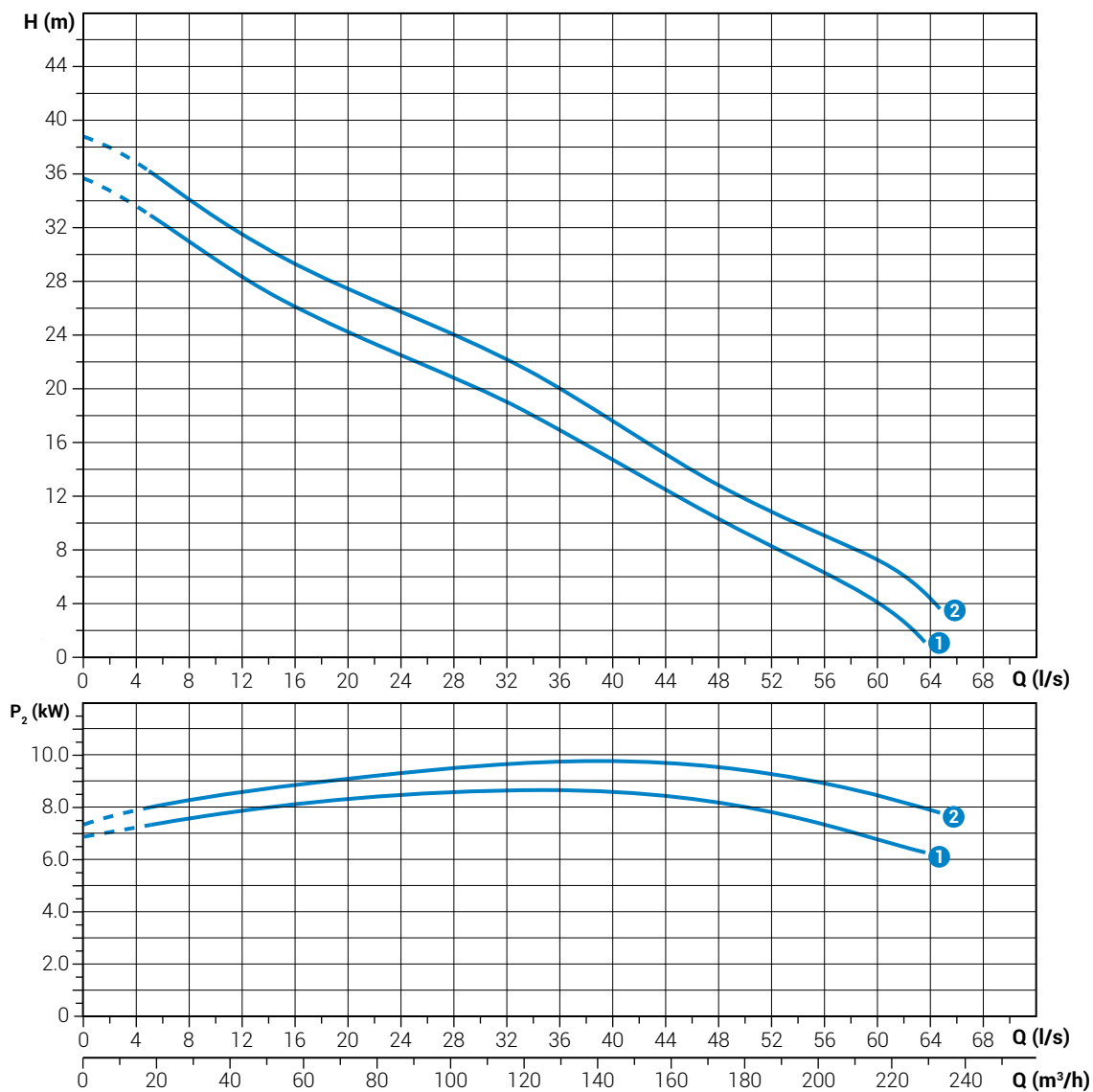

**DRG 1200÷1500/2/100****Характеристики**

	l/s	0	8	16	24	32	40	48	56	64
	l/min	0	480	960	1440	1920	2400	2880	3360	3840
	m ³ /h	0	28.8	57.6	86.4	115.2	144	172.8	201.6	230.4
1	DRG 1200/2/100 K0GT5	35.8	31.0	26.2	22.6	19.1	14.8	10.3	6.3	
2	DRG 1500/2/100 K0GT5	38.8	34.2	29.3	25.8	22.2	17.6	12.9	9.1	4.4



Диапазоны мощности соответствуют нормативу UNI EN ISO 9906

Технические данные

	V	1~ 3~	P ₁ [kW]	P ₂ [kW]	A	Rpm	DOL Y/Δ				
1	DRG 1200/2/100 K0GT5	400	3~	10.4	9.0	16.1	2900	Y/Δ	7G1.5+3x1	DN100	45 mm
2	DRG 1500/2/100 K0GT5	400	3~	12.6	11.0	19.5	2900	Y/Δ	7G1.5+3x1	DN100	45 mm

DRG 200÷400/4/80

Характеристики

	l/s	0	4	8	12	16	20	24	28	32	64
	l/min	0	240	480	720	960	1200	1440	1680	1920	3840
	m³/h	0	14.4	28.8	43.2	57.6	72	86.4	100.8	115.2	230.4
① DRG 200/4/80 M0ET5		8.6	7.7	6.7	5.6	4.4	2.9	1.3			
② DRG 300/4/80 G0ET5		12.8	11.6	10.2	8.8	7.5	6.3	4.9	3.4	1.6	1.6
③ DRG 400/4/80 H0ET5		14.6	13.4	12.0	10.6	9.2	7.8	6.4	4.8	3.0	3.0

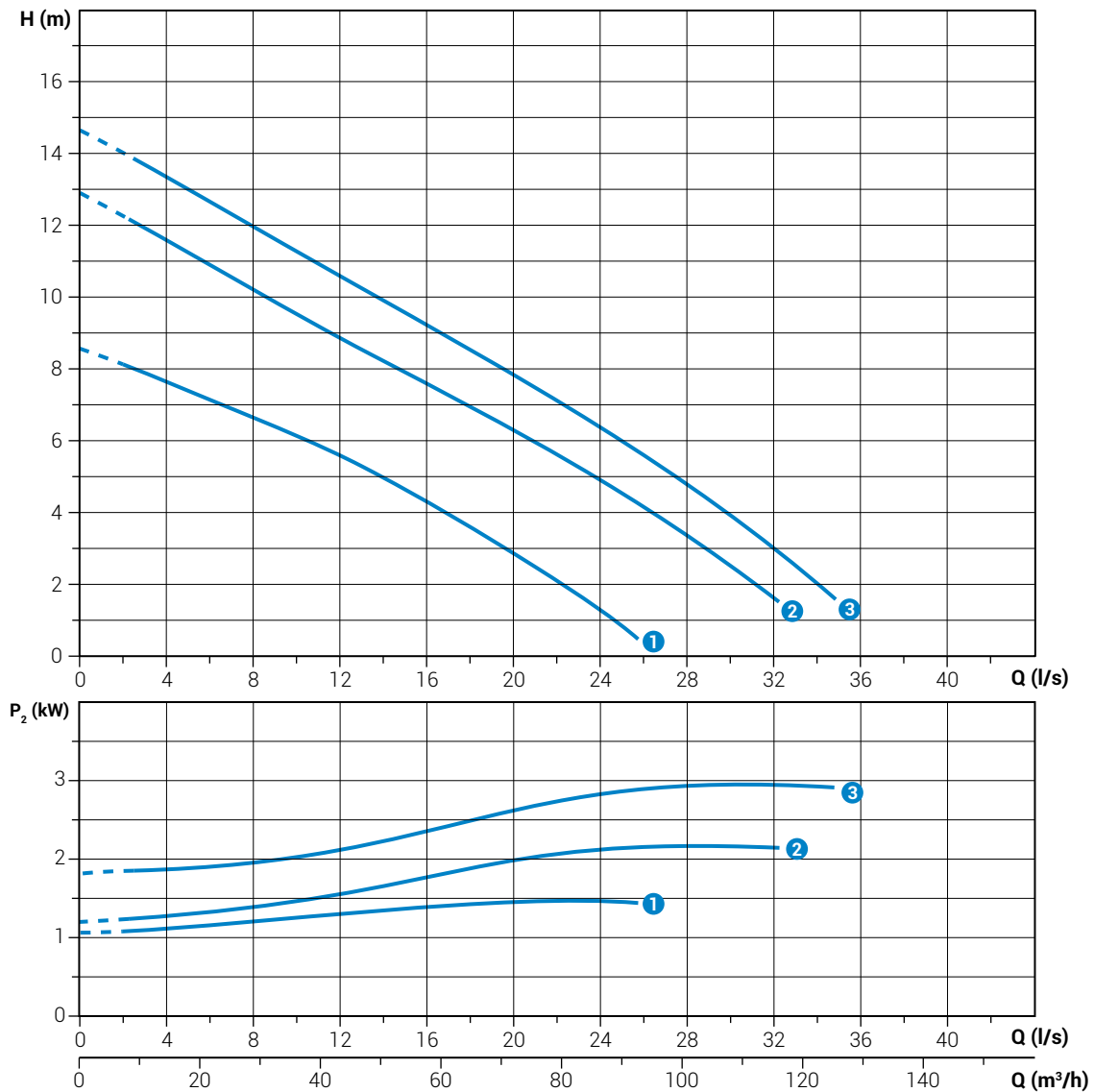

Диапазоны мощности соответствуют нормативу UNI EN ISO 9906

Технические данные

	V	1~ 3~	P ₁ [kW]	P ₂ [kW]	A	Rpm	DOL Y/Δ			
① DRG 200/4/80 M0ET5	400	3~	1.8	1.5	3.4	1450	DOL	4G1.5+3x1	DN80	45 mm
② DRG 300/4/80 G0ET5	400	3~	2.7	2.2	5.2	1450	DOL	4G1.5+3x1	DN80	75 mm
③ DRG 400/4/80 H0ET5	400	3~	3.7	3.0	6.7	1450	DOL	4G1.5+3x1	DN80	75 mm

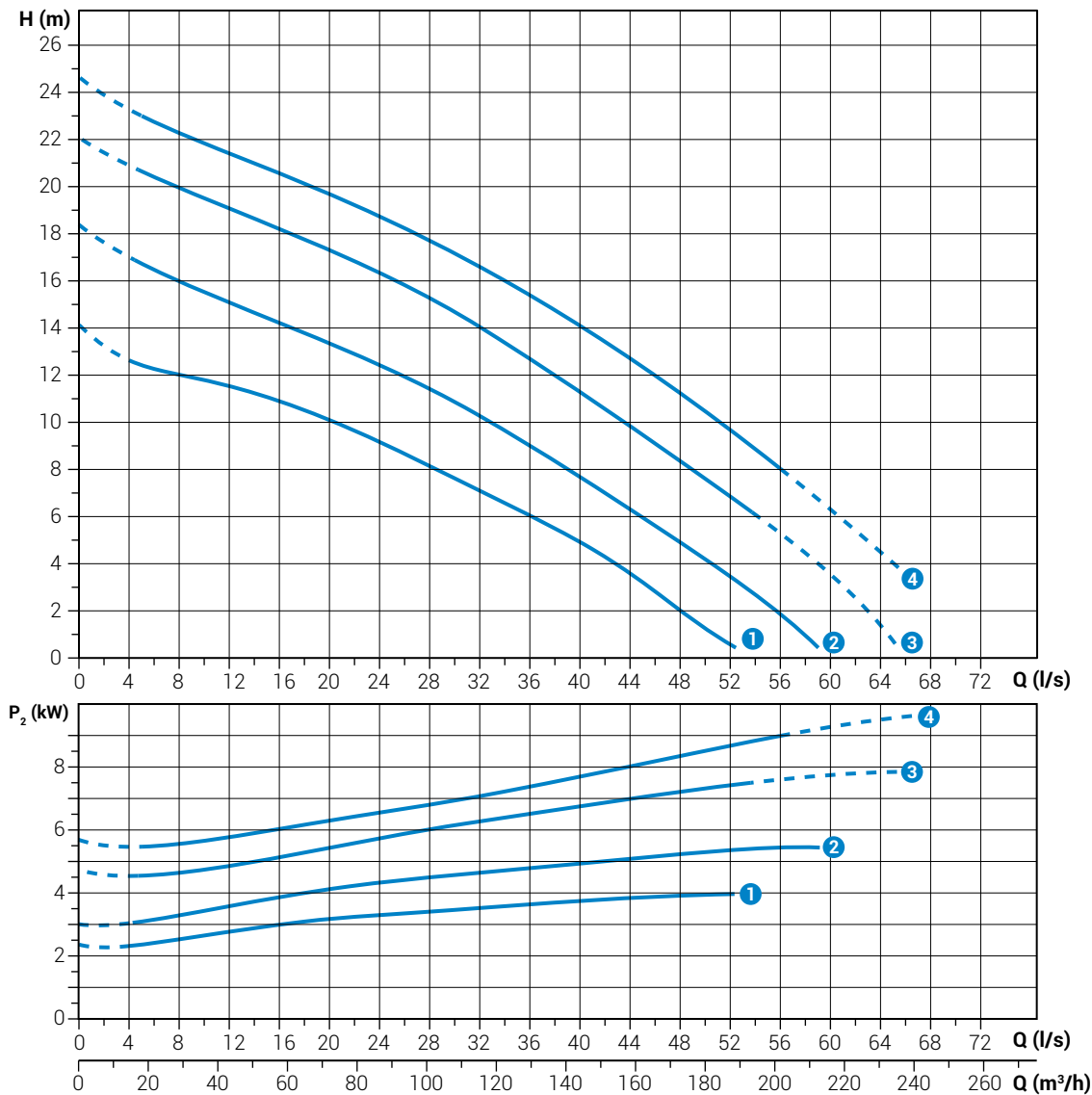

**DRG 550÷1200/4/80****Характеристики**

	l/s	0	4	8	12	16	20	24	28	32	36	40	44	48	52
	l/min	0	240	480	720	960	1200	1440	1680	1920	2160	2400	2640	2880	3120
	m ³ /h	0	14.4	28.8	43.2	57.6	72	86.4	100.8	115.2	129.6	144	158.4	172.8	187.2
① DRG 550/4/80 D0FT5		14.1	12.6	12.0	11.5	10.9	10.0	9.1	8.1	7.1	6.1	4.9	3.6	2.1	0.6
② DRG 750/4/80 D0FT5		18.4	17.0	16.0	15.1	14.3	13.4	12.5	11.5	10.3	9.0	7.7	6.3	4.9	3.5
③ DRG 1000/4/80 D0GT5		22.0	21.0	20.0	19.1	18.3	17.4	16.4	15.3	14.1	12.7	11.3	9.9	8.4	6.9
④ DRG 1200/4/80 D0HT5		24.6	23.2	22.2	21.4	20.6	19.7	18.8	17.7	16.6	15.3	14.0	12.6	1.1	9.6



Диапазоны мощности соответствуют нормативу UNI EN ISO 9906

Технические данные

	V	1~ 3~	P ₁ [kW]	P ₂ [kW]	A	Rpm	DOL Y/Δ			
① DRG 550/4/80 D0FT5	400	3~	4.6	4.0	8.4	1450	DOL	4G1.5+3x1	DN80	65x60 mm
② DRG 750/4/80 D0FT5	400	3~	6.4	5.5	11.8	1450	DOL	4G1.5+3x1	DN80	65x60 mm
③ DRG 1000/4/80 D0GT5	400	3~	8.7	7.5	15.8	1450	Y/Δ	7G1.5+3x1	DN80	65x60 mm
④ DRG 1200/4/80 D0HT5	400	3~	10.2	9.0	17.0	1450	Y/Δ	7G1.5+3x1	DN80	65x60 mm



DRG 200÷400/4/100

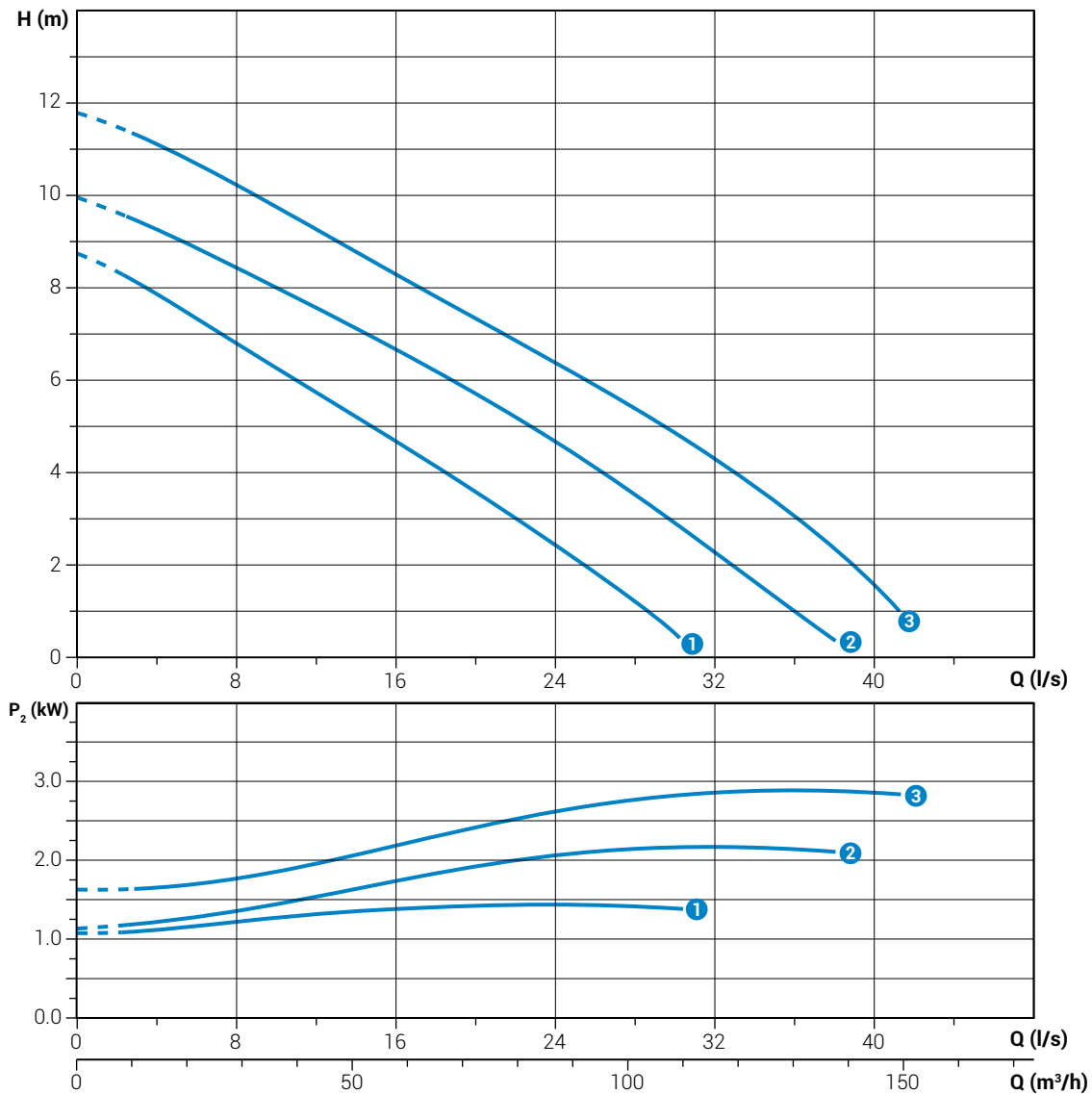

Характеристики

	l/s	0	4	8	12	16	20	24	28	32	36	40
	l/min	0	240	480	720	960	1200	1440	1680	1920	2160	2400
	m ³ /h	0	14.4	28.8	43.2	57.6	72	86.4	100.8	115.2	129.6	144
①	DRG 200/4/100 T0ET5	8.7	7.9	6.8	5.7	4.7	3.8	2.4	1.2			
②	DRG 300/4/100 U0ET5	9.9	9.2	8.4	7.5	6.6	5.7	4.7	3.5	2.3	1.0	
③	DRG 400/4/100 U0ET5	11.8	11.1	10.2	9.2	8.3	7.3	6.4	5.4	4.3	3.0	1.6



Диапазоны мощности соответствуют нормативу UNI EN ISO 9906

Технические данные

	V	1~ 3~	P ₁ [kW]	P ₂ [kW]	A	Rpm	DOL Y/Δ				
①	DRG 200/4/100 T0ET5	400	3~	1.8	1.5	3.4	1450	DOL	4G1.5+3x1	DN100	45 mm
②	DRG 300/4/100 U0ET5	400	3~	2.7	2.2	5.2	1450	DOL	4G1.5+3x1	DN100	60 mm
③	DRG 400/4/100 U0ET5	400	3~	3.7	3.0	6.7	1450	DOL	4G1.5+3x1	DN100	60 mm

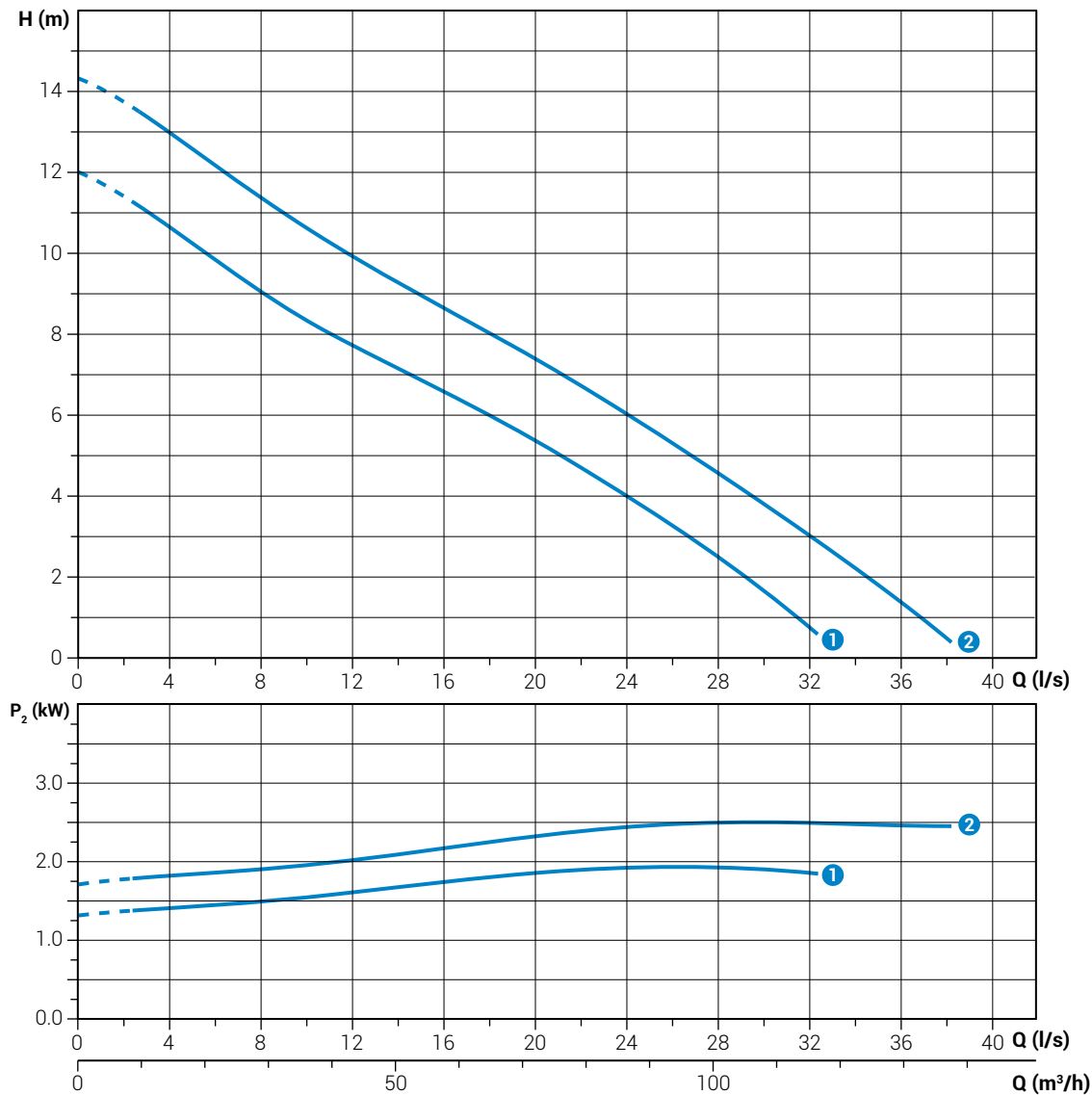

**DRG 300÷400/4/100****Характеристики**

	l/s	0	4	8	12	16	20	24	28	32	36
	l/min	0	240	480	720	960	1200	1440	1680	1920	2160
	m ³ /h	0	14.4	28.8	43.2	57.6	72	86.4	100.8	115.2	129.6
1	DRG 300/4/100 X0ET5	12.0	10.6	9.1	7.7	6.6	5.4	4.0	2.5	0.7	
2	DRG 400/4/100 Y0ET5	14.3	13.0	11.4	9.9	8.6	7.4	6.0	4.6	3.0	1.4



Диапазоны мощности соответствуют нормативу UNI EN ISO 9906

Технические данные

	V	1~ 3~	P ₁ [kW]	P ₂ [kW]	A	Rpm	DOL Y/Δ			
1	400	3~	2.7	2.2	5.2	1450	DOL	4G1.5+3x1	DN100	75 mm
2	400	3~	3.7	3.0	6.7	1450	DOL	4G1.5+3x1	DN100	75 mm



DRG 550÷1200/4/100

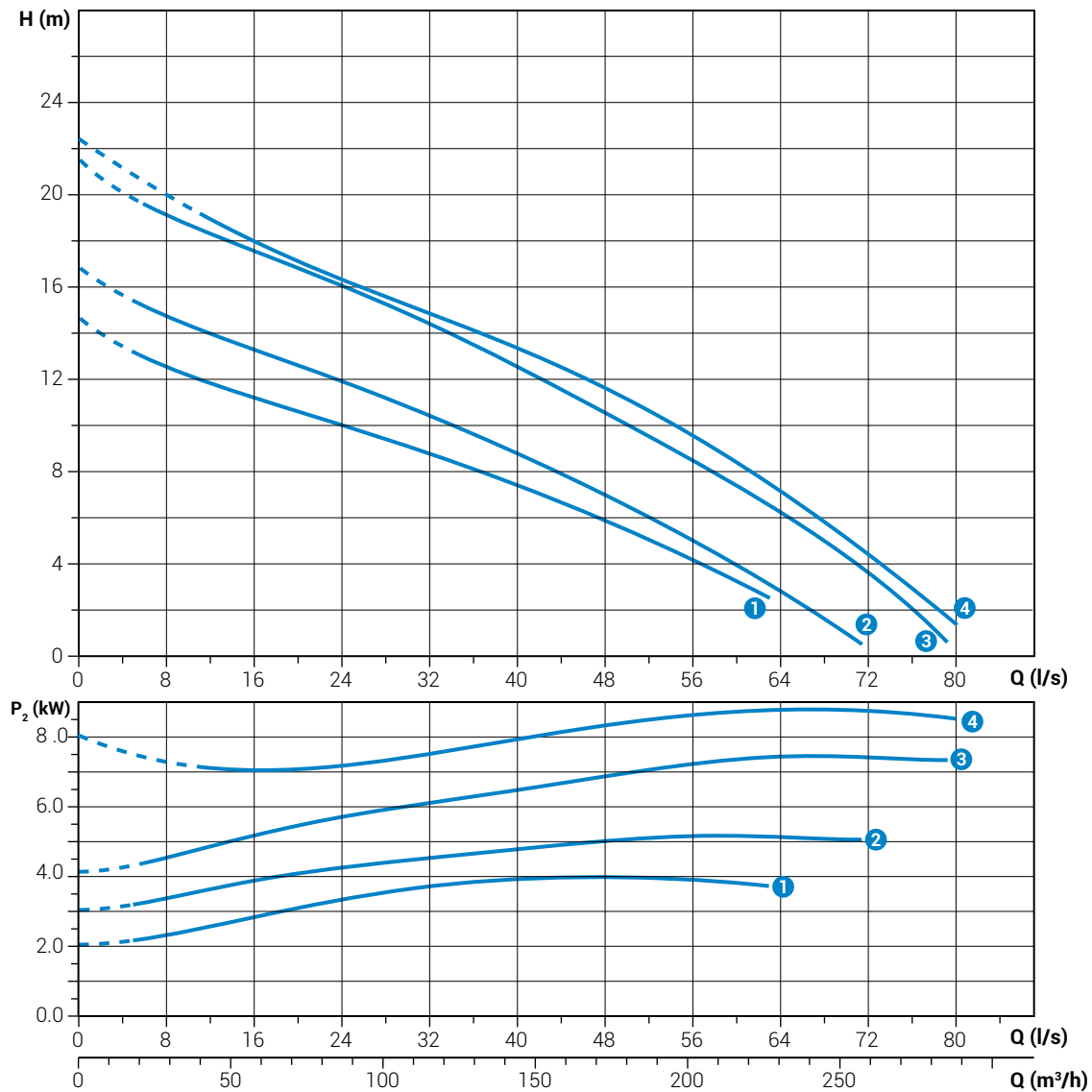

Характеристики

	l/s	0	8	16	24	32	40	48	56	64	72	80
	l/min	0	480	960	1440	1920	2400	2880	3360	3840	4320	4800
	m³/h	0	28.8	57.6	86.4	115.2	144	172.8	201.6	230.4	259.2	288
①	DRG 550/4/100 ROFT5	15.6	12.5	11.2	10.0	8.8	7.4	5.8	4.2			
②	DRG 750/4/100 LOFT5	16.9	14.7	13.3	11.9	10.4	8.7	7.0	5.0	2.8		
③	DRG 1000/4/100 LOGT5	21.4	19.1	17.6	16.1	14.4	12.5	10.5	8.5	6.2	3.6	
④	DRG 1200/4/100 HOHT5	22.4	20.0	18.0	16.4	14.8	13.3	11.6	9.6	7.2	4.4	1.3



Диапазоны мощности соответствуют нормативу UNI EN ISO 9906

Технические данные

	V	1~ 3~	P ₁ [kW]	P ₂ [kW]	A	Rpm	DOL Y/Δ				
①	DRG 550/4/100 ROFT5	400	3~	4.6	4.0	8.4	1450	DOL	4G1.5+3x1	DN100	65 mm
②	DRG 750/4/100 LOFT5	400	3~	6.4	5.5	11.8	1450	DOL	4G1.5+3x1	DN100	65x60 mm
③	DRG 1000/4/100 LOGT5	400	3~	8.7	7.5	15.8	1450	DOL	7G1.5+3x1	DN100	65x60 mm
④	DRG 1200/4/100 HOHT5	400	3~	10.2	9.0	17.0	1450	Y/Δ	7G1.5+3x1	DN100	80 mm

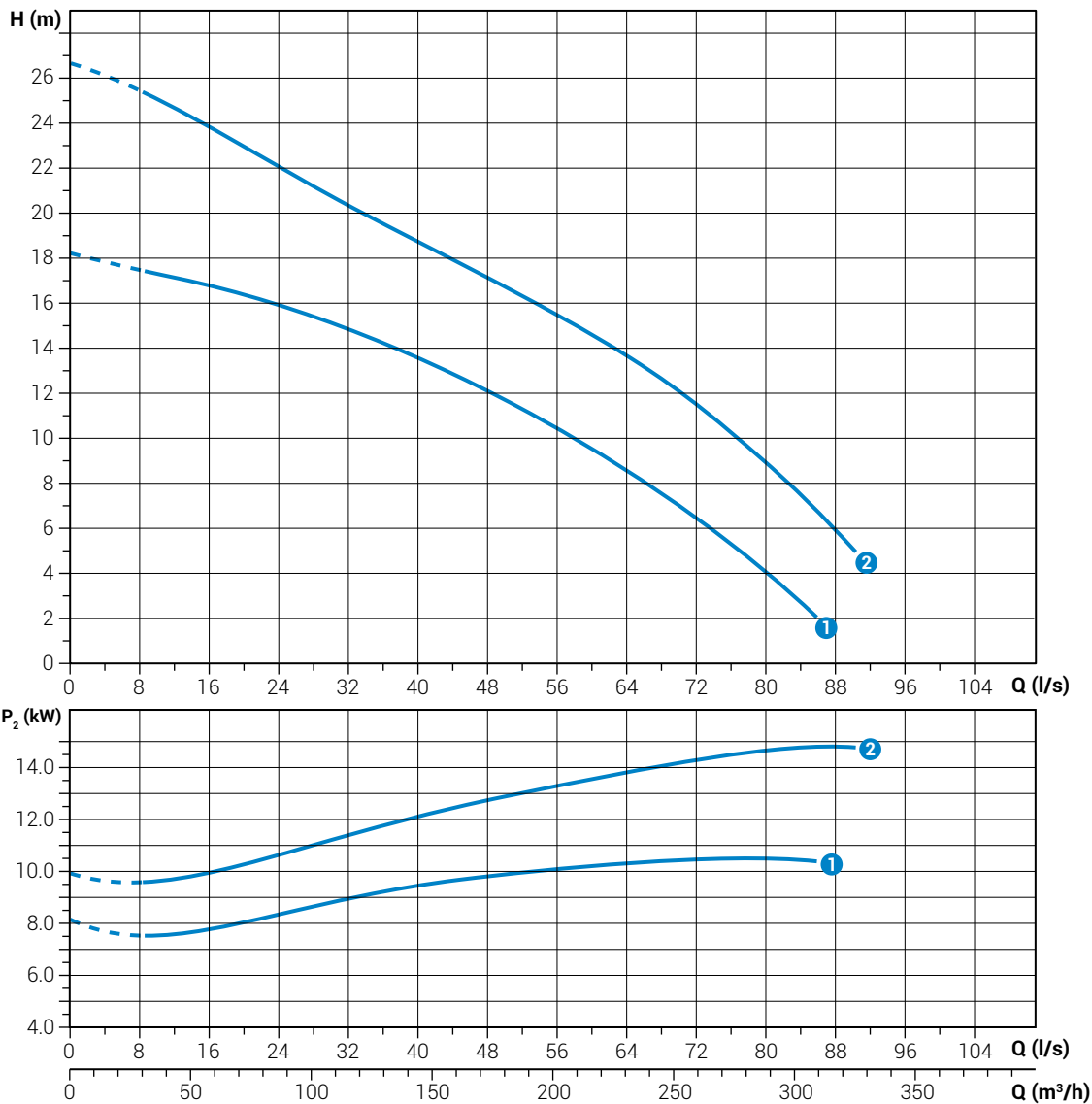

**DRG 1500÷2000/4/100****Характеристики**

	l/s	0	8	16	24	32	40	48	56	64	72	80	88
	l/min	0	480	960	1440	1920	2400	2880	3360	3840	4320	4800	5280
	m ³ /h	0	28.8	57.6	86.4	115.2	144	172.8	201.6	230.4	259.2	288	316.8
①	DRG 1500/4/100 A0HT5	18.2	17.5	16.8	15.9	14.8	13.5	12.0	10.4	8.5	6.5	4.0	
②	DRG 2000/4/100 A0HT5	26.6	25.4	23.8	22.0	20.3	18.7	17.1	15.5	13.6	11.5	8.9	5.8



Диапазоны мощности соответствуют нормативу UNI EN ISO 9906

Технические данные

	V	1~ 3~	P ₁ [kW]	P ₂ [kW]	A	Rpm	DOL Y/Δ				
①	DRG 1500/4/100 A0HT5	400	3~	12.6	11.0	20.5	1450	Y/Δ	7G1.5+3x1	DN100	80 mm
②	DRG 2000/4/100 A0HT5	400	3~	16.7	15.0	30.8	1450	Y/Δ	7G2.5+3x1	DN100	80 mm



DRG 1200÷2000/4/100

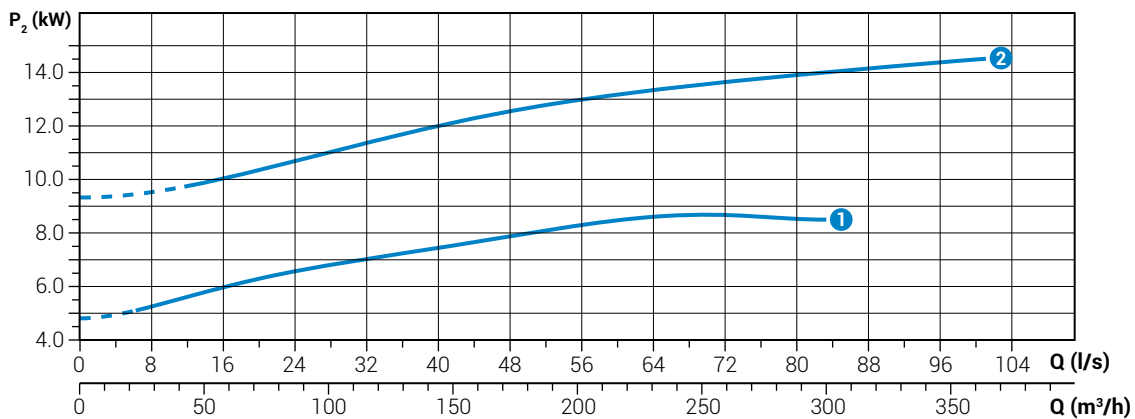
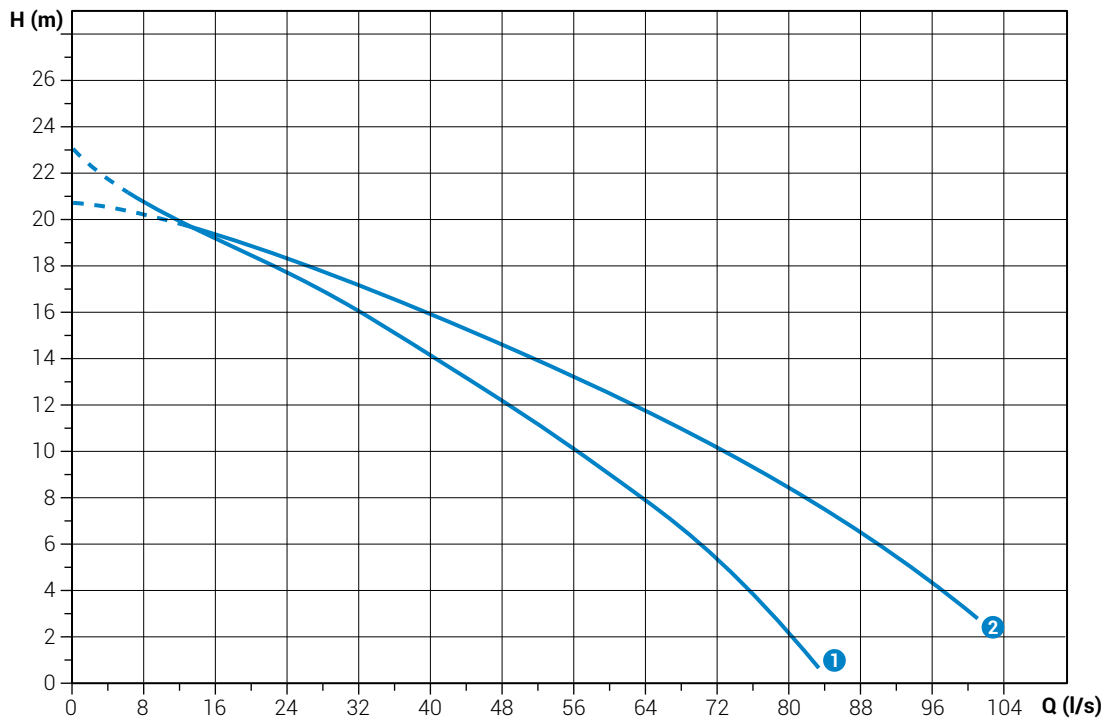

Характеристики

	l/s	0	8	16	24	32	40	48	56	64	72	80	88	96
	l/min	0	480	960	1440	1920	2400	2880	3360	3840	4320	4800	5280	5760
	m³/h	0	28.8	57.6	86.4	115.2	144	172.8	201.6	230.4	259.2	288	316.8	345.6
①	DRG 1200/4/100 L0HT5	23.1	20.7	19.2	17.7	16.0	14.2	12.2	10.1	7.9	5.3	2.2		
②	DRG 2000/4/100 B0HT5	20.7	20.2	19.4	18.3	17.2	15.9	14.6	13.2	11.7	10.2	8.4	6.5	4.3



Диапазоны мощности соответствуют нормативу UNI EN ISO 9906

Технические данные

	V	1~ 3~	P ₁ [kW]	P ₂ [kW]	A	Rpm	DOL Y/Δ				
①	DRG 1200/4/100 L0HT5	400	3~	10.2	9.0	17.0	1450	Y/Δ	7G1.5+3x1	DN100	65x60
②	DRG 2000/4/100 B0HT5	400	3~	16.7	15.0	30.8	1450	Y/Δ	7G2.5+3x1	DN100	80 mm

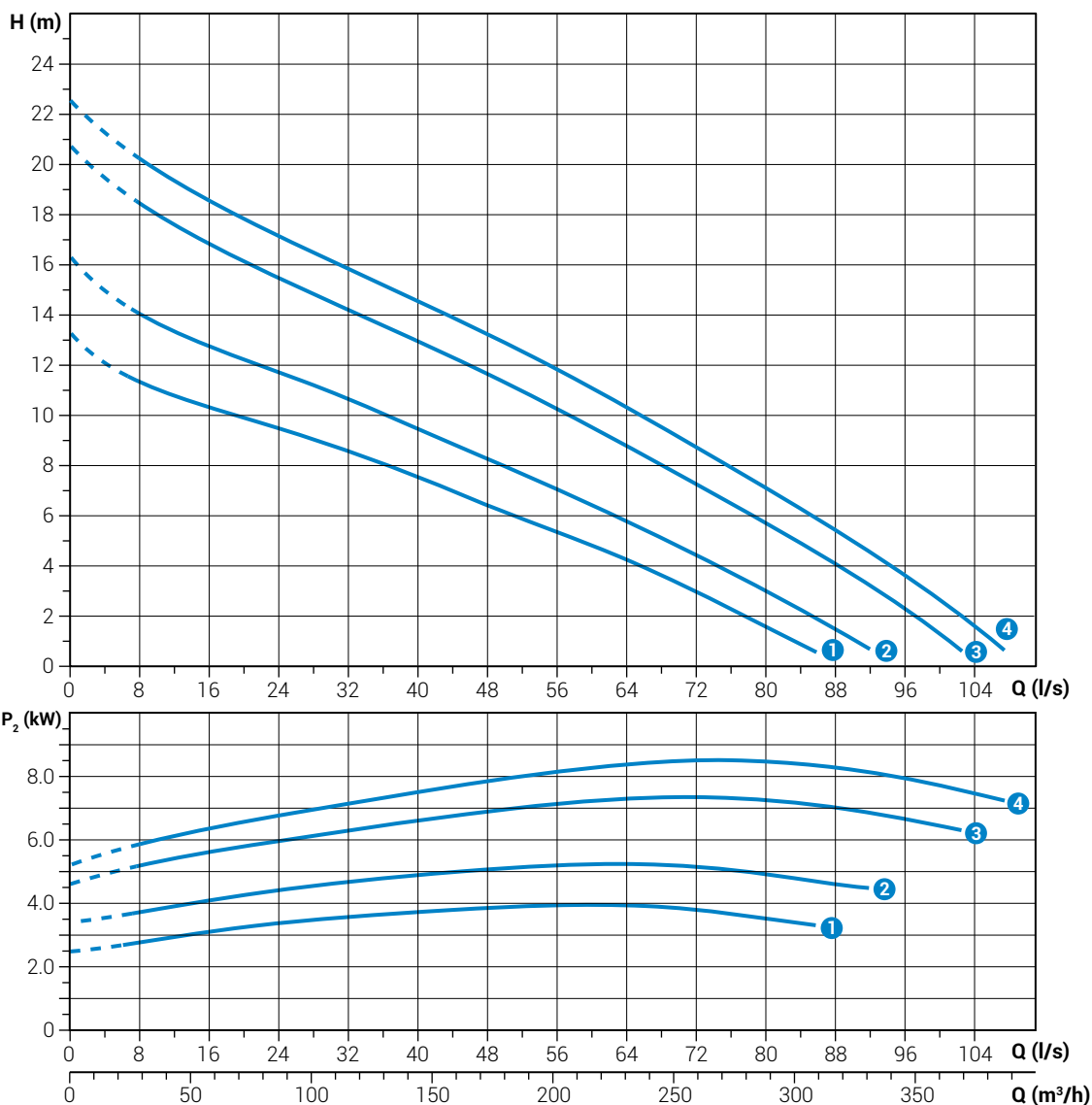

**DRG 550÷1200/4/150****Характеристики**

	l/s	0	8	16	24	32	40	48	56	64	72	80	88	96	104
	l/min	0	480	960	1440	1920	2400	2880	3360	3840	4320	4800	5280	5760	6240
	m ³ /h	0	28.8	57.6	86.4	115.2	144	172.8	201.6	230.4	259.2	288	316.8	345.6	374.4
① DRG 550/4/150 NOFT5		13.3	11.3	10.3	9.5	8.6	7.5	6.4	5.4	4.2	3.0	1.6			
② DRG 750/4/150 NOFT5		16.3	14.0	12.7	11.7	10.6	9.5	8.2	7.0	5.7	4.4	3.0	1.4		
③ DRG 1000/4/150 NOGT5		20.8	18.5	16.8	15.5	14.3	13.0	11.7	10.3	8.8	7.2	5.7	4.1	2.3	
④ DRG 1200/4/150 NOHT5		22.5	20.2	18.5	17.1	15.9	14.6	13.2	11.8	10.3	8.7	7.1	5.4	3.7	1.6



Диапазоны мощности соответствуют нормативу UNI EN ISO 9906

Технические данные

	V	1~ 3~	P ₁ [kW]	P ₂ [kW]	A	Rpm	DOL Y/Δ			
① DRG 550/4/150 NOFT5	400	3~	4.6	4.0	8.4	1450	DOL	4G1.5+3x1	DN150	65x60
② DRG 750/4/150 NOFT5	400	3~	6.4	5.5	11.8	1450	DOL	4G1.5+3x1	DN150	65x60
③ DRG 1000/4/150 NOGT5	400	3~	8.7	7.5	15.8	1450	Y/Δ	7G1.5+3x1	DN150	65x60
④ DRG 1200/4/150 NOHT5	400	3~	10.2	9.0	17.0	1450	Y/Δ	7G1.5+3x1	DN150	65x60





DRG 1200÷2000/4/150

Характеристики

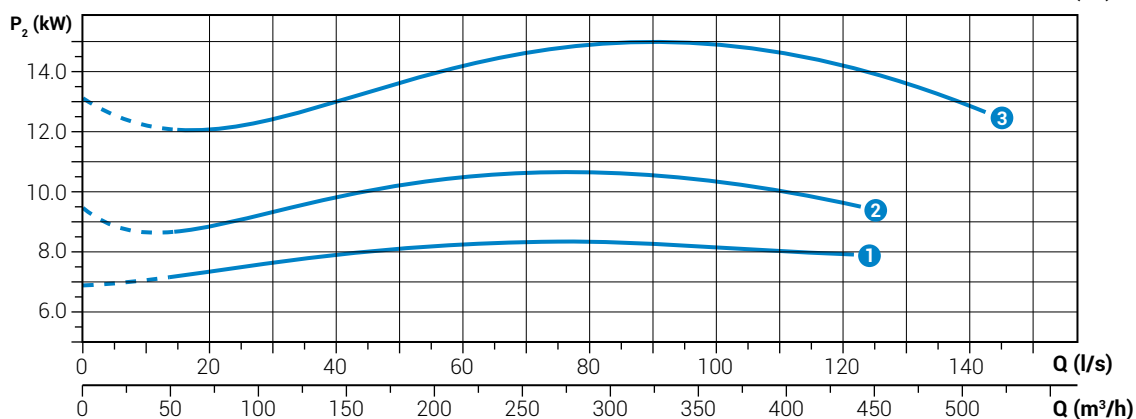
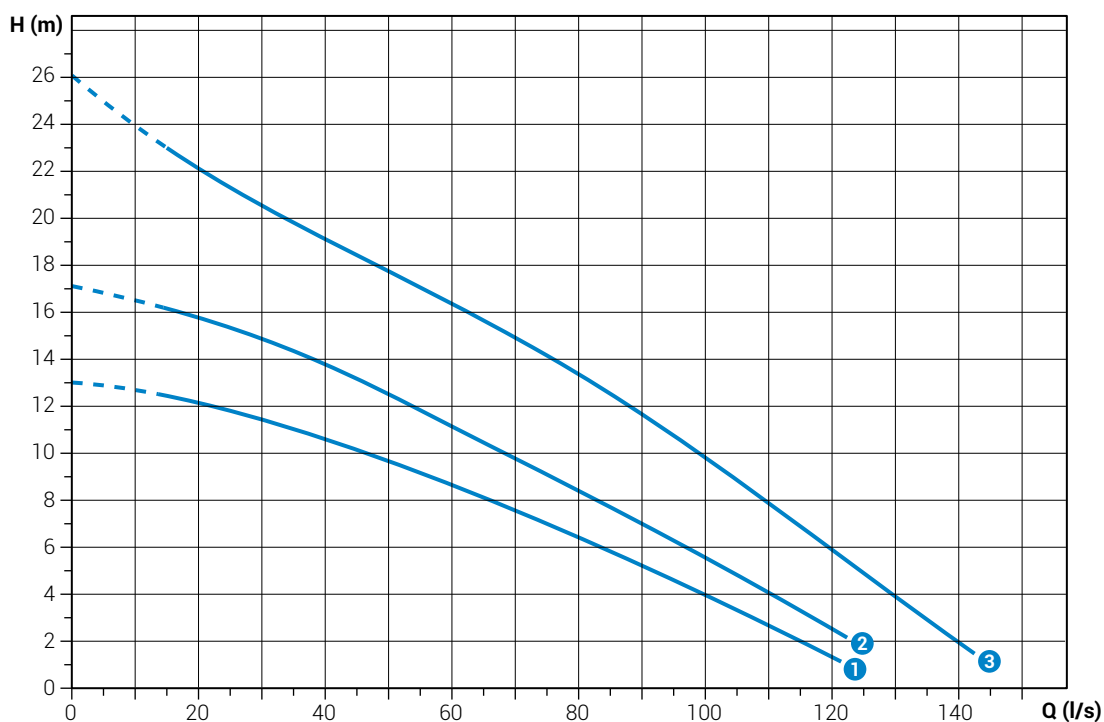
	l/s	0	12	24	36	48	60	72	84	96	108	120	132
	l/min	0	720	1440	2160	2880	3600	4320	5040	5760	6480	7200	7920
	m³/h	0	43.2	86.4	129.6	172.8	216	259.2	302.4	345.6	388.8	432	475.2
① DRG 1200/4/150 A0HT5		13.0	12.6	11.9	10.9	9.9	8.6	7.3	5.9	4.5	2.9	1.3	
② DRG 1500/4/150 A0HT5		17.1	16.4	15.5	14.3	12.8	11.2	9.5	7.8	6.1	4.4	2.5	
③ DRG 2000/4/150 A0HT5		26.1	23.5	21.4	19.6	18.0	16.6	14.6	12.7	10.5	8.2	5.8	3.4



Технические данные

	V	1~ 3~	P ₁ [kW]	P ₂ [kW]	A	Rpm	DOL Y/Δ			
① DRG 1200/4/150 A0HT5	400	3~	10.2	9.0	17.0	1450	Y/Δ	7G1.5+3x1	DN150	80 mm
② DRG 1500/4/150 A0HT5	400	3~	12.6	11.0	20.5	1450	Y/Δ	7G1.5+3x1	DN150	80 mm
③ DRG 2000/4/150 A0HT5	400	3~	16.7	15.0	30.8	1450	Y/Δ	7G2.5+3x1	DN150	80 mm

Диапазоны мощности соответствуют нормативу UNI EN ISO 9906

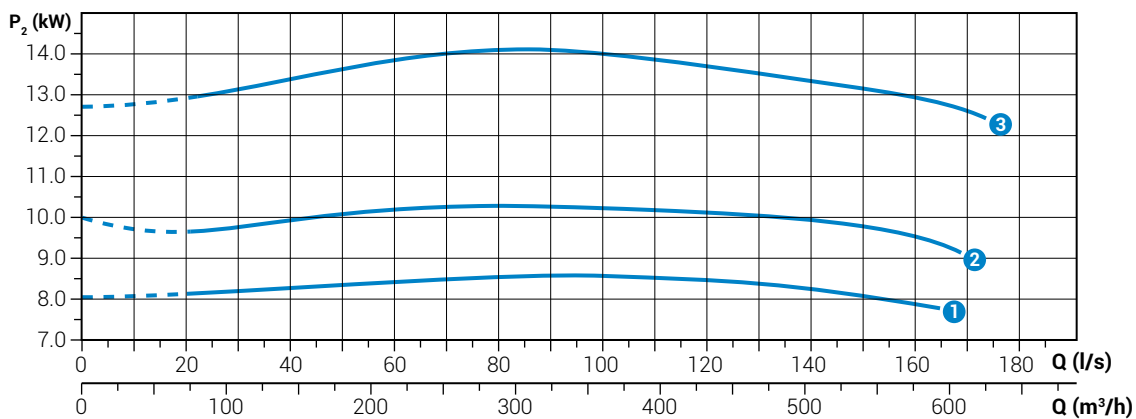
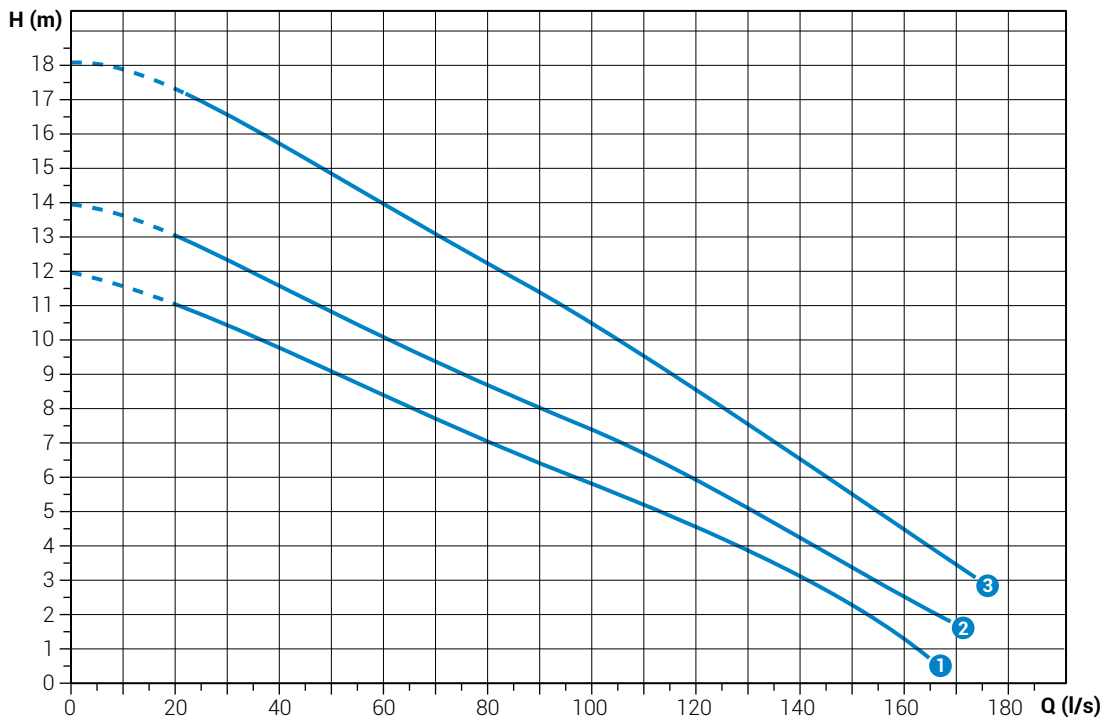

**DRG 1200÷2000/4/200****Характеристики**

	l/s	0	16	32	48	64	80	96	112	128	144	160
	l/min	0	960	1920	2880	3840	4800	5760	6720	7680	8640	9600
	m ³ /h	0	57.6	115.2	172.8	230.4	288	345.6	403.2	460.8	518.4	576
① DRG 1200/4/200 B0HT5		11.9	11.2	10.3	9.2	8.1	7.0	6.0	5.0	4.0	2.8	1.2
② DRG 1500/4/200 B0HT5		13.9	13.3	12.1	10.9	9.7	8.6	7.6	6.5	5.2	3.8	2.4
③ DRG 2000/4/200 B0HT5		18.1	17.6	16.4	15.0	13.6	12.2	10.8	9.3	7.7	6.1	4.5



Диапазоны мощности соответствуют нормативу UNI EN ISO 9906

Технические данные

	V	1~ 3~	P ₁ [kW]	P ₂ [kW]	A	Rpm	DOL Y/Δ			
① DRG 1200/4/200 B0HT5	400	3~	10.2	9.0	17.0	1450	Y/Δ	7G1.5+3x1	DN200	80 mm
② DRG 1500/4/200 B0HT5	400	3~	12.6	11.0	20.5	1450	Y/Δ	7G1.5+3x1	DN200	80 mm
③ DRG 2000/4/200 B0HT5	400	3~	16.7	15.0	30.8	1450	Y/Δ	7G2.5+3x1	DN200	80 mm





DRG 1200÷2000/4/250

Характеристики

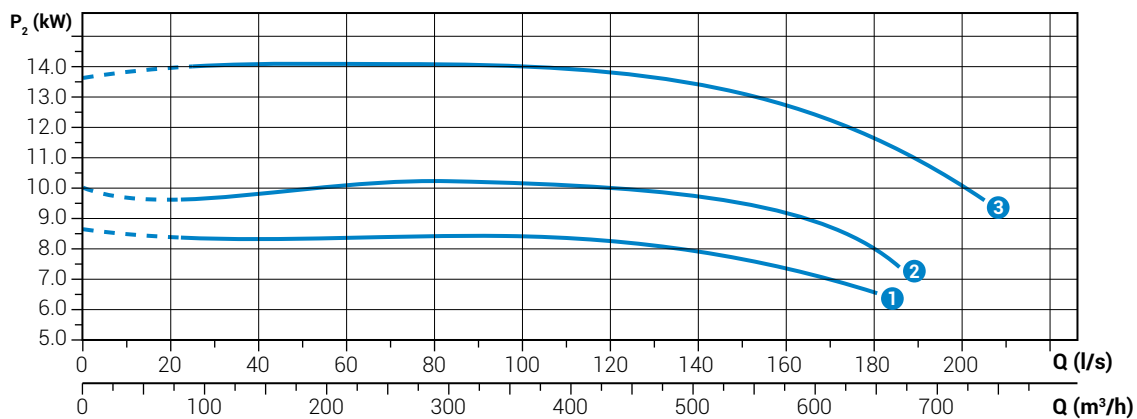
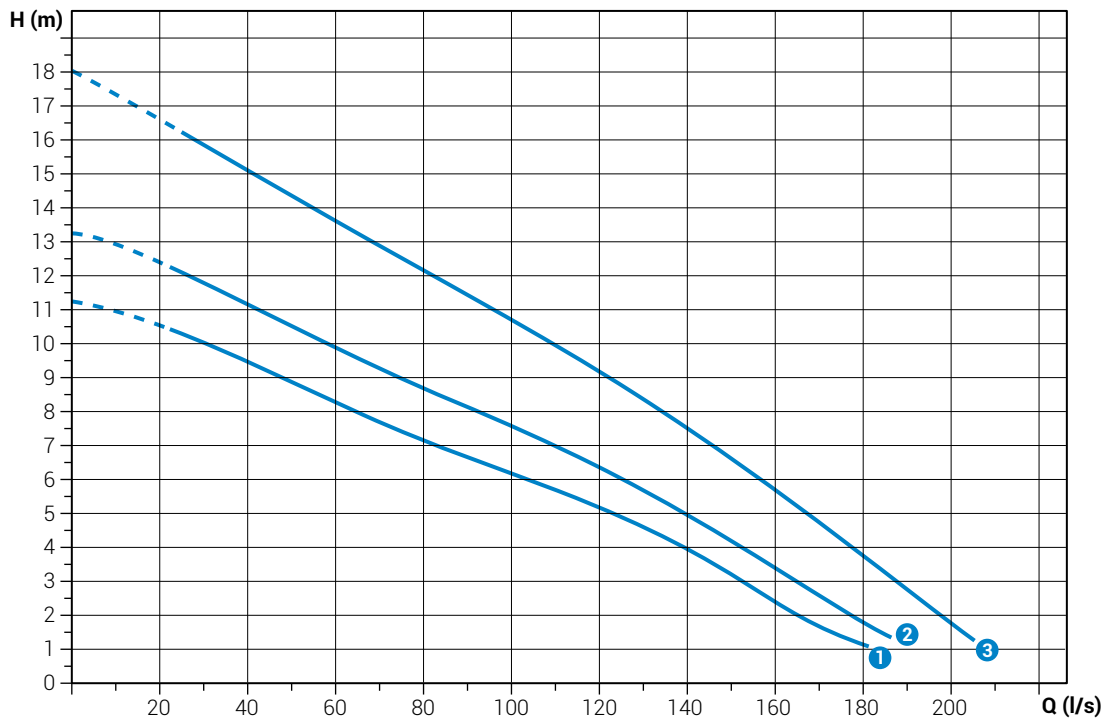
	l/s	0	16	32	48	64	80	96	112.0	128	144	160	176	192
	l/min	0	960	1920	2880	3840	4800	5760	6720	7680	8640	9600	10560	11520
	m³/h	0	57.6	115.2	172.8	230.4	288	345.6	403.2	460.8	518.4	576	633.6	691.2
①	DRG 1200/4/250 H0HT5	11.3	10.8	9.9	9.0	8.0	7.2	6.4	5.6	4.7	3.6	2.4	1.3	
②	DRG 1500/4/250 H0HT5	13.3	12.7	11.7	10.7	9.7	8.7	7.8	6.9	5.8	4.7	3.4	2.1	
③	DRG 2000/4/250 H0HT5	18.1	16.9	15.7	14.5	13.3	12.2	11	9.8	8.6	7.2	5.7	4.1	2.5



Технические данные

	V	1~ 3~	P ₁ [kW]	P ₂ [kW]	A	Rpm	DOL Y/Δ				
①	DRG 1200/4/250 H0HT5	400	3~	10.2	9.0	17.0	1450	Y/Δ	7G1.5+3x1	DN250	80 mm
②	DRG 1500/4/250 H0HT5	400	3~	12.6	11.0	20.5	1450	Y/Δ	7G1.5+3x1	DN250	80 mm
③	DRG 2000/4/250 H0HT5	400	3~	16.7	15.0	30.8	1450	Y/Δ	7G2.5+3x1	DN250	80 mm

Диапазоны мощности соответствуют нормативу UNI EN ISO 9906

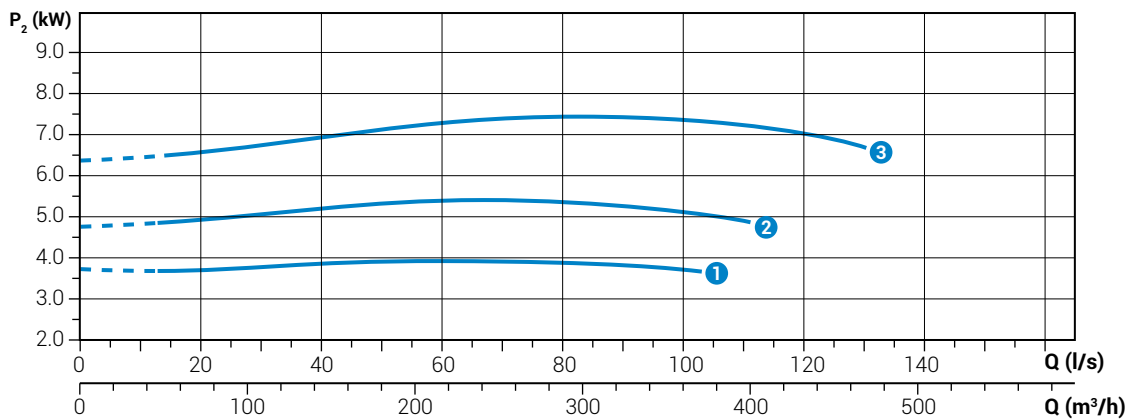
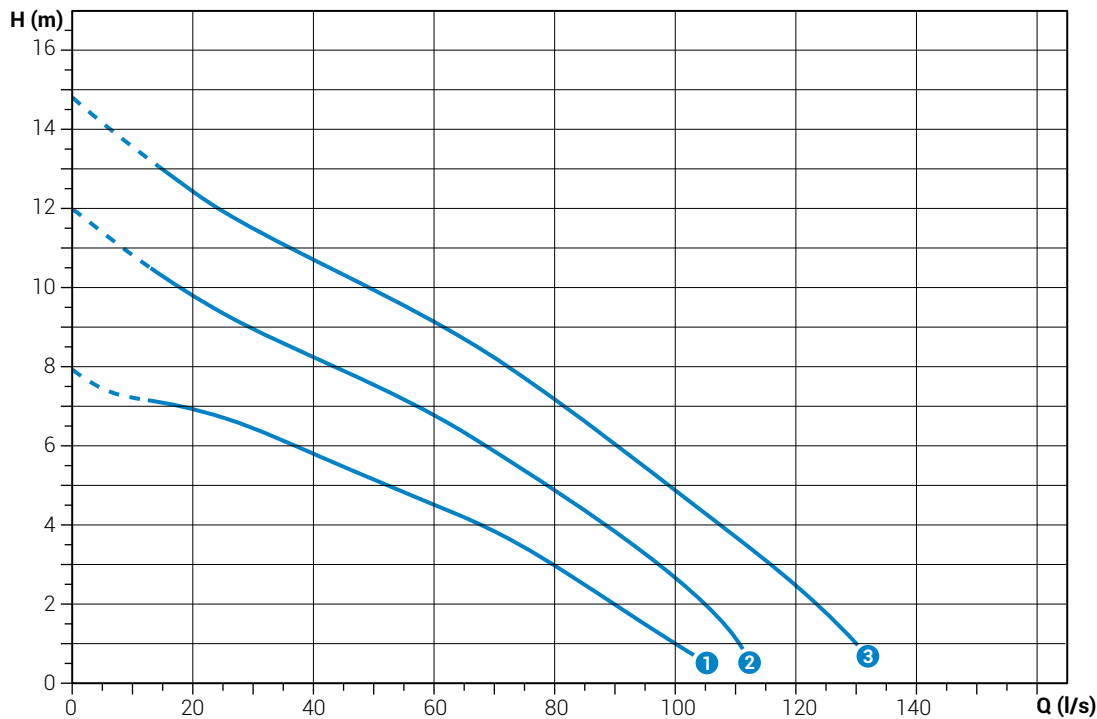

**DRG 550÷1000/6/150****Характеристики**

	l/s	0	12	24	36	48	60	72	84	96	108	120
	l/min	0	720	1440	2160	2880	3600	4320	5040	5760	6480	7200
	m ³ /h	0	43.2	86.4	129.6	172.8	216	259.2	302.4	345.6	388.8	432
1	DRG 550/6/150 F0GT5	7.9	7.2	6.8	6.1	5.3	4.5	3.7	2.6	1.4		
2	DRG 750/6/150 F0GT5	11.9	10.6	9.4	8.5	7.7	6.8	5.7	4.4	3.1	1.4	
3	DRG 1000/6/150 F0HT5	14.8	13.2	12.0	11.0	10.1	9.1	8.0	6.7	5.3	3.9	2.5



Диапазоны мощности соответствуют нормативу UNI EN ISO 9906

Технические данные

	V	1~ 3~	P ₁ [kW]	P ₂ [kW]	A	Rpm	DOL Y/Δ				
1	DRG 550/6/150 F0GT5	400	3~	4.9	4.0	9.3	960	Y/Δ	7G1.5+3x1	DN150	80 mm
2	DRG 750/6/150 F0GT5	400	3~	6.6	5.5	12.8	960	Y/Δ	7G1.5+3x1	DN150	80 mm
3	DRG 1000/6/150 F0HT5	400	3~	8.9	7.5	15.7	960	Y/Δ	7G1.5+3x1	DN150	80 mm



DRG 1000÷1750/6/200

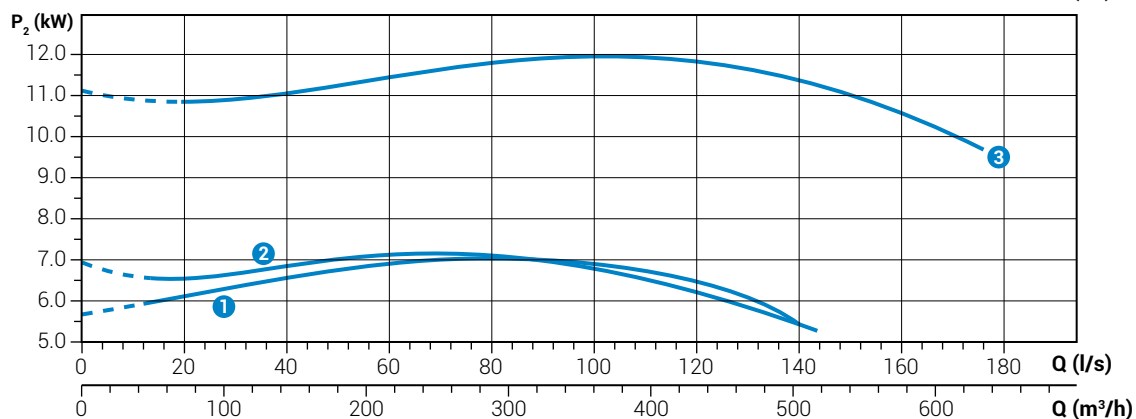
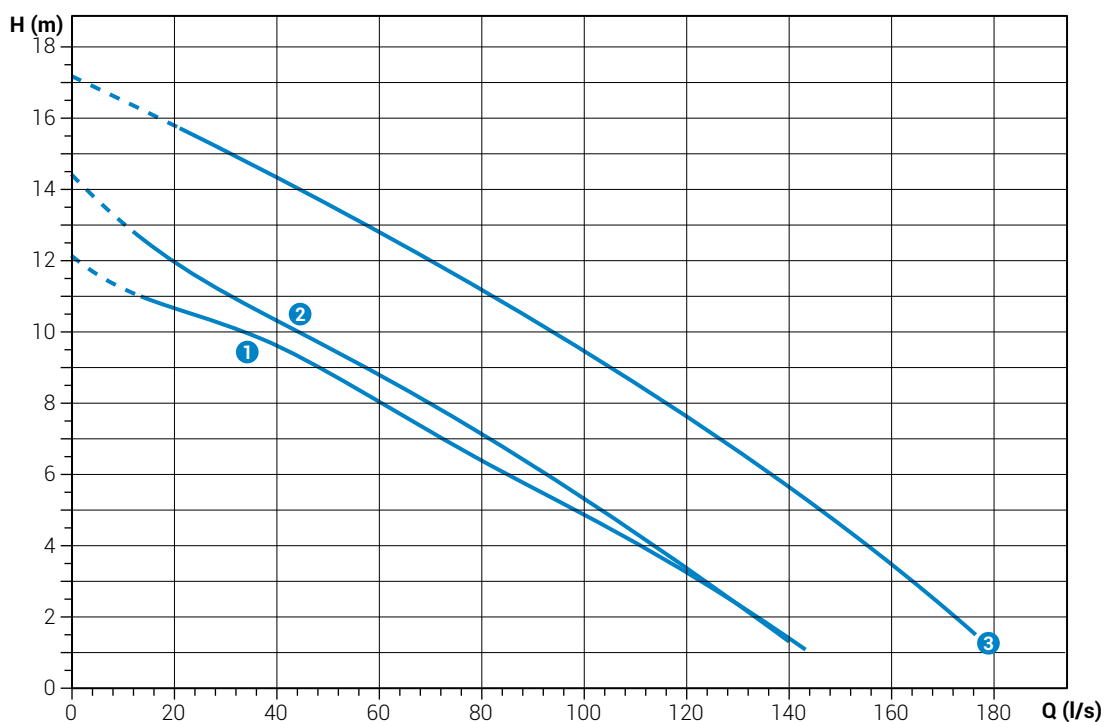

Характеристики

	l/s	0	16	32	48	64	80	96	112.0	128	144	160
	l/min	0	960	1920	2880	3840	4800	5760	6720	7680	8640	9600
	m³/h	0	57.6	115.2	172.8	230.4	288	345.6	403.2	460.8	518.4	576
①	DRG 1000/6/200 A0HT5	12.2	10.9	10.1	9.0	7.7	6.4	5.1	3.9	2.5		
②	DRG 1000/6/200 B0HT5	14.4	12.4	10.9	9.7	8.4	7.0	5.6	4.3	2.6		
③	DRG 1750/6/200 A0HT5	17.2	16.1	14.9	13.8	12.5	11.2	9.8	8.4	6.9	5.2	3.4



Диапазоны мощности соответствуют нормативу UNI EN ISO 9906

Технические данные

	V	1~ 3~	P ₁ [kW]	P ₂ [kW]	A	Rpm	DOL Y/Δ				
①	DRG 1000/6/200 A0HT5	400	3~	8.9	7.5	15.7	960	Y/Δ	7G1.5+3x1	DN200	100x70 mm
②	DRG 1000/6/200 B0HT5	400	3~	8.9	7.5	15.7	960	Y/Δ	7G1.5+3x1	DN200	80 mm
③	DRG 1750/6/200 A0HT5	400	3~	15.0	13.0	27.6	960	Y/Δ	7G2.5+3x1	DN200	100x70 mm

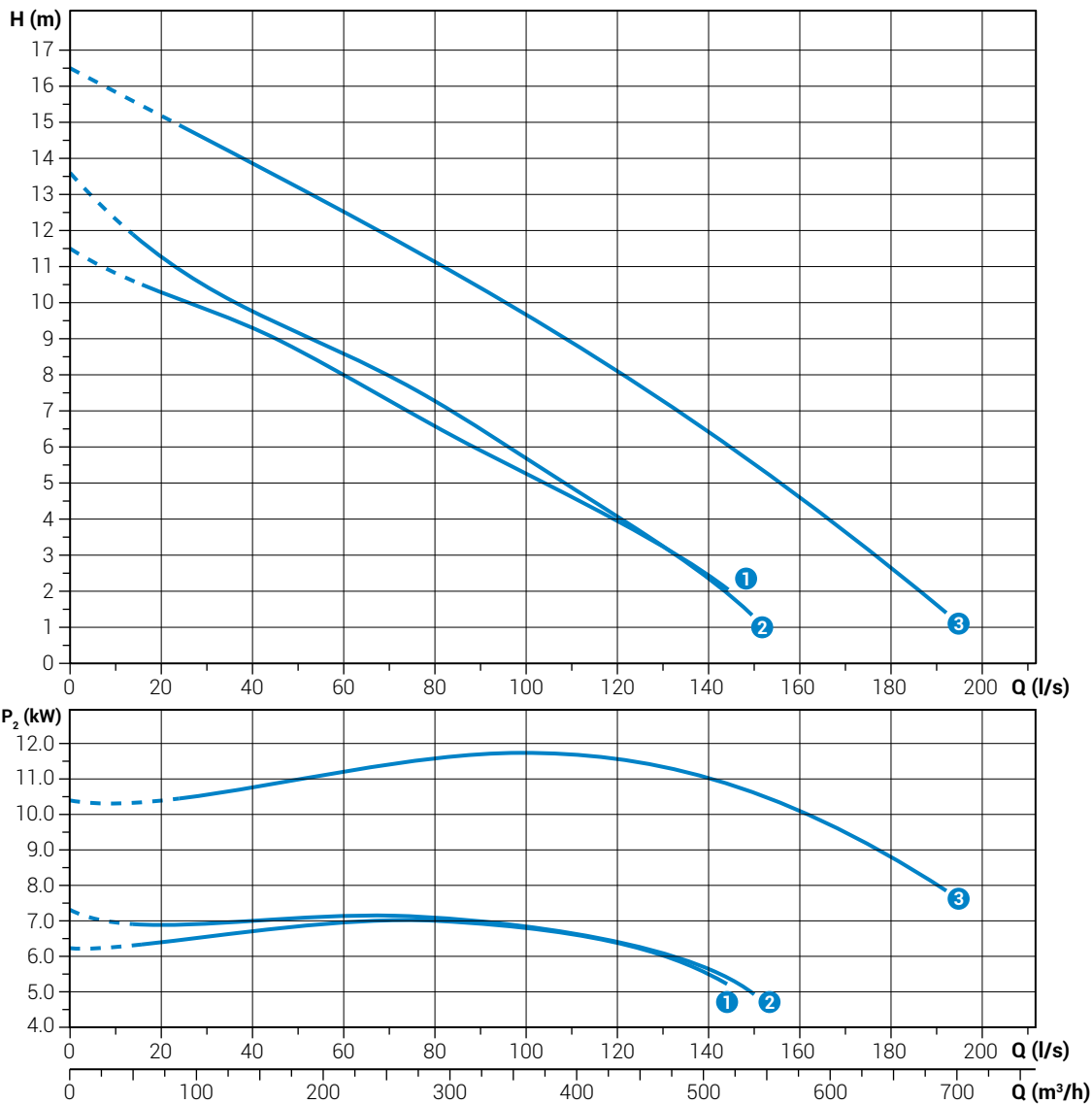

**DRG 1000÷1750/6/250****Характеристики**

	l/s	0	16	32	48	64	80	96	112	128	144	160	176	192
	l/min	0	960	1920	2880	3840	4800	5760	6720	7680	8640	9600	10560	11520
	m ³ /h	0	57.6	115.2	172.8	230.4	288	345.6	403.2	460.8	518.4	576	633.6	691.2
① DRG 1000/6/250 C0HT5		11.5	10.5	9.7	8.9	7.8	6.6	5.5	4.5	3.4	2.1			
② DRG 1000/6/250 H0HT5		13.6	11.6	10.3	9.3	8.3	7.3	6.0	4.7	3.4	2.0			
③ DRG 1750/6/250 C0HT5		16.5	15.4	14.4	13.3	12.2	11.1	10.0	8.8	7.5	6.1	4.6	3.1	1.4



Диапазоны мощности соответствуют нормативу UNI EN ISO 9906

Технические данные

	V	1~ 3~	P ₁ [kW]	P ₂ [kW]	A	Rpm	DOL Y/Δ			
① DRG 1000/6/250 C0HT5	400	3~	8.9	7.5	15.7	960	DOL	7G1.5+3x1	DN250	100x70 mm
② DRG 1000/6/250 H0HT5	400	3~	8.9	7.5	15.7	960	DOL	7G1.5+3x1	DN250	80 mm
③ DRG 1750/6/250 C0HT5	400	3~	15.0	13.0	27.6	960	DOL	7G2.5+3x1	DN250	100x70 mm

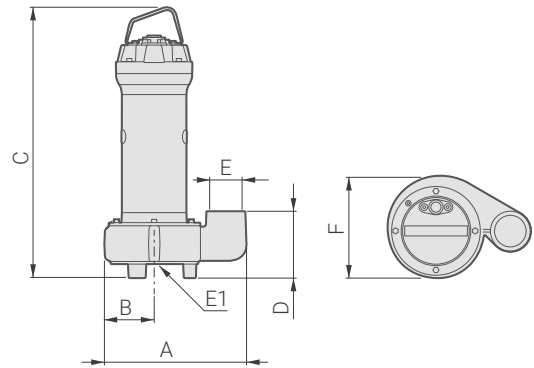
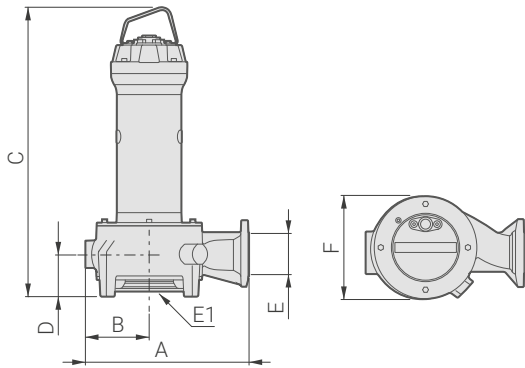

DRG





	A	B	C	D	E	E1	F	kg
DRG 75/2/G40V A3AM5	255	115	488	145	G1½"	-	220	24.0
DRG 75/2/G40V A3AT5	255	115	488	145	G1½"	-	220	24.0
DRG 100/2/G40V A3AM5	255	115	488	145	G1½"	-	220	25.0
DRG 100/2/G40V A3AT5	255	115	488	145	G1½"	-	220	25.0
DRG 150/2/G50V A3AM5	274	110	564	164	G2"	-	220	26.5
DRG 150/2/G50V A3AT5	274	110	564	164	G2"	-	220	26.5
DRG 200/2/G50V A3AM5	274	110	564	164	G2"	-	220	27.0
DRG 200/2/G50V A3AT5	274	110	564	164	G2"	-	220	27.0
DRG 250/2/G65V B0AT5	327	116	541	153	G2½"	65	240	33.0
DRG 300/2/G65V A0ET5	327	116	565	153	G2½"	65	240	42.2
DRG 400/2/G65V A0ET5	327	116	615	153	G2½"	65	240	45.0

	A	B	C	D	E	E1	F		kg
DRG 75/2/G40H A3AM5	263	110	489	101	G1½"	-	220	DN32 PN6	25.0
DRG 75/2/G40H A3AT5	263	110	489	101	G1½"	-	220	DN32 PN6	25.0
DRG 100/2/G40H A3AM5	263	110	489	101	G1½"	-	220	DN32 PN6	26.0
DRG 100/2/G40H A3AT5	263	110	489	101	G1½"	-	220	DN32 PN6	26.0
DRG 150/2/G50H A3AM5	268	110	564	104	G2"	-	220	DN32 PN6	27.5
DRG 150/2/G50H A3AT5	268	110	564	104	G2"	-	220	DN32 PN6	27.5
DRG 200/2/G50H A3AM5	268	110	564	104	G2"	-	220	DN32 PN6	28.0
DRG 200/2/G50H A3AT5	268	110	564	104	G2"	-	220	DN32 PN6	28.0
DRG 250/2/65 B0AT5	344	136	543	80	65	65	255	DN65 PN10-16	34.0
DRG 300/2/65 A0ET5	344	136	565	80	65	65	255	DN65 PN10-16	59.6
DRG 400/2/65 A0ET5	344	136	615	80	65	65	255	DN65 PN10-16	61.6
DRG 550/2/65 C0FT5	343	136	698	88	65	65	253	DN65 PN10-16	63.6
DRG 250/2/80 L0AT5	347	135	542	80	80	80	252	DN80 PN10-16	36.0
DRG 300/2/80 E0ET5	347	135	564	80	80	80	252	DN80 PN10-16	60.6
DRG 400/2/80 E0ET5	347	135	614	80	80	80	252	DN80 PN10-16	62.6
DRG 550/2/80 B0FT5	327	142	707	91	80	80	271	DN80 PN10-16	68.0
DRG 550/2/80 P0FT5	343	136	698	88	80	80	253	DN80 PN10-16	63.6

**DRG**

	A	B	C	D	E	E1	F		
DRG 750/2/80 A0FT5	327	142	707	91	80	80	271	DN80 PN10-16	71.3
DRG 750/2/80 B0FT5	327	142	707	91	80	80	271	DN80 PN10-16	71.3
DRG 1000/2/80 A0FT5	327	142	782	91	80	80	271	DN80 PN10-16	79.2
DRG 1000/2/80 B0FT5	327	142	782	91	80	80	271	DN80 PN10-16	79.2
DRG 1200/2/80 A0GT5	327	142	850	91	80	80	271	DN80 PN10-16	104.5
DRG 1200/2/80 B0GT5	327	142	850	91	80	80	271	DN80 PN10-16	104.5
DRG 1500/2/80 A0GT5	327	142	850	91	80	80	271	DN80 PN10-16	105.7
DRG 1500/2/80 B0GT5	327	142	850	91	80	80	271	DN80 PN10-16	105.7
DRG 2000/2/80 G0HT5	393	151	930	88	80	80	293	DN80 PN10-16	155.0
DRG 2000/2/80 W0HT5	481	188	980	124	80	150	360	DN80 PN10-16	183.0
DRG 2500/2/80 G0HT5	393	151	1033	88	80	80	293	DN80 PN10-16	165.0
DRG 2500/2/80 W0HT5	481	188	1070	124	80	150	360	DN80 PN10-16	193.0
DRG 200/4/80 M0ET5	394	151	603	88	80	80	292	DN80 PN10-16	55.2
DRG 300/4/80 G0ET5	393	151	653	88	80	80	292	DN80 PN10-16	60.2
DRG 400/4/80 H0ET5	393	151	653	88	80	80	291	DN80 PN10-16	61.8
DRG 550/4/80 D0FT5	481	188	831	124	80	150	367	DN80 PN10-16	110.0
DRG 750/4/80 D0FT5	481	188	831	124	80	150	367	DN80 PN10-16	110.2
DRG 1000/4/80 D0GT5	481	188	899	124	80	150	367	DN80 PN10-16	141.0
DRG 1200/4/80 D0HT5	481	188	980	124	80	150	367	DN80 PN10-16	183.0
DRG 200/4/100 T0ET5	417	160	603	91	100	100	310	DN100 PN10-16	58.2
DRG 300/4/100 U0ET5	417	160	653	91	100	100	310	DN100 PN10-16	63.2
DRG 300/4/100 X0ET5	417	160	653	91	100	100	310	DN100 PN10-16	63.2
DRG 400/4/100 U0ET5	417	160	653	91	100	100	310	DN100 PN10-16	64.8
DRG 400/4/100 Y0ET5	417	160	653	91	100	100	310	DN100 PN10-16	64.8
DRG 550/4/100 R0FT5	449	183	780	91	100	100	353	DN100 PN10-16	90.0
DRG 750/4/100 L0FT5	552	212	832	124	100	150	400	DN100 PN10-16	112.2
DRG 1000/4/100 L0GT5	552	212	900	124	100	150	400	DN100 PN10-16	143.0
DRG 1200/4/100 H0HT5	548	208	979	124	100	150	413	DN100 PN10-16	195.0
DRG 1200/4/100 L0HT5	552	212	980	124	100	150	400	DN100 PN10-16	185.0
DRG 1500/4/100 A0HT5	548	208	979	124	100	100	413	DN100 PN10-16	200.0
DRG 2000/4/100 A0HT5	548	208	1069	124	100	100	413	DN100 PN10-16	212.0
DRG 2000/4/100 B0HT5	590	240	1072	121	100	100	471	DN100 PN10-16	212.0
DRG 550/4/150 N0FT5	616	227	838	130	150	150	449	DN150 PN10-16	120.0
DRG 750/4/150 N0FT5	616	227	838	130	150	150	449	DN150 PN10-16	120.2
DRG 1000/4/150 N0GT5	616	227	905	130	150	150	449	DN150 PN10-16	151.0
DRG 1200/4/150 A0HT5	612	222	985	130	150	150	447	DN150 PN10-16	212.0
DRG 1200/4/150 N0HT5	616	227	985	130	150	150	449	DN150 PN10-16	193.0
DRG 1500/4/150 A0HT5	612	222	985	130	150	150	447	DN150 PN10-16	212.0
DRG 2000/4/150 A0HT5	612	222	1075	130	150	150	447	DN150 PN10-16	224.0
DRG 1200/4/200 B0HT5	692	273	1046	172	200	200	539	DN200 PN10	239.0
DRG 1500/4/200 B0HT5	692	273	1136	172	200	200	539	DN200 PN10	239.0
DRG 2000/4/200 B0HT5	692	273	1136	172	200	200	539	DN200 PN10	251.0
DRG 1200/4/250 H0HT5	808	334	1046	203	250	200	609	DN250 PN10	270.0
DRG 1500/4/250 H0HT5	808	334	1136	203	250	200	609	DN250 PN10	270.0

**DRG**

	A	B	C	D	E	E1	F		
DRG 2000/4/250 H0HT5	808	334	1136	203	250	200	609	DN250 PN10	282.0
DRG 550/6/150 F0GT5	647	252	1015	172	150	200	507	DN150 PN10-16	193.0
DRG 750/6/150 F0GT5	647	252	1015	172	150	200	507	DN150 PN10-16	195.0
DRG 1000/6/150 F0HT5	647	252	1047	172	150	200	507	DN150 PN10-16	235.0
DRG 1000/6/200 A0HT5	692	273	1077	203	200	250	539	DN200 PN10	276.8
DRG 1000/6/200 B0HT5	692	273	1046	172	200	200	539	DN200 PN10	239.0
DRG 1750/6/200 A0HT5	692	273	1167	203	200	250	539	DN200 PN10	239.8
DRG 1000/6/250 C0HT5	808	334	1078	203	250	250	609	DN250 PN10	302.3
DRG 1000/6/250 H0HT5	808	334	1046	203	250	200	609	DN250 PN10	270.0
DRG 1750/6/250 C0HT5	808	334	1168	203	250	250	609	DN250 PN10	319.3

**DRG**

	X	Y	Z
DRG 75/2/G40V A3AM5	310	580	310
DRG 75/2/G40V A3AT5	310	580	310
DRG 100/2/G40V A3AM5	310	580	310
DRG 100/2/G40V A3AT5	310	580	310
DRG 150/2/G50V A3AM5	310	580	310
DRG 150/2/G50V A3AT5	310	580	310
DRG 200/2/G50V A3AM5	310	580	310
DRG 200/2/G50V A3AT5	310	580	310
DRG 250/2/G65V B0AT5	445	725	425
DRG 300/2/G65V A0ET5	445	725	425
DRG 400/2/G65V A0ET5	445	725	425
DRG 75/2/G40H A3AM5	310	580	310
DRG 75/2/G40H A3AT5	310	580	310
DRG 100/2/G40H A3AM5	310	580	310
DRG 100/2/G40H A3AT5	310	580	310
DRG 150/2/G50H A3AM5	310	580	310
DRG 150/2/G50H A3AT5	310	580	310
DRG 200/2/G50H A3AM5	310	580	310
DRG 200/2/G50H A3AT5	310	580	310
DRG 250/2/65 B0AT5	445	725	425
DRG 300/2/65 A0ET5	445	725	425
DRG 400/2/65 A0ET5	445	725	425
DRG 550/2/65 C0FT5	445	725	425
DRG 250/2/80 L0AT5	445	725	425
DRG 300/2/80 E0ET5	445	725	425
DRG 400/2/80 E0ET5	445	725	425
DRG 550/2/80 B0FT5	445	725	425
DRG 550/2/80 P0FT5	445	725	425
DRG 750/2/80 A0FT5	445	725	425
DRG 750/2/80 B0FT5	445	725	425
DRG 1000/2/80 A0FT5	535	915	560
DRG 1000/2/80 B0FT5	535	915	560
DRG 1200/2/80 A0GT5	535	915	560
DRG 1200/2/80 B0GT5	535	915	560
DRG 1500/2/80 A0GT5	535	915	560
DRG 1500/2/80 B0GT5	535	915	560
DRG 2000/2/80 G0HT5	535	1000	560
DRG 2000/2/80 W0HT5	535	915	560
DRG 2500/2/80 G0HT5	725	1270	675
DRG 2500/2/80 W0HT5	725	1270	675
DRG 1200/2/100 K0GT5	535	915	560
DRG 1500/2/100 K0GT5	535	915	560
DRG 200/4/80 M0ET5	445	725	425
DRG 300/4/80 G0ET5	445	725	425

DRG



	X	Y	Z
DRG 400/4/80 H0ET5	445	725	425
DRG 550/4/80 D0FT5	535	915	560
DRG 750/4/80 D0FT5	535	915	560
DRG 1000/4/80 D0GT5	535	915	560
DRG 1200/4/80 D0HT5	725	1270	675
DRG 200/4/100 T0ET5	445	725	425
DRG 300/4/100 U0ET5	445	725	425
DRG 300/4/100 X0ET5	445	725	425
DRG 400/4/100 U0ET5	445	725	425
DRG 400/4/100 Y0ET5	445	725	425
DRG 550/4/100 R0FT5	535	915	560
DRG 750/4/100 L0FT5	725	1270	675
DRG 1000/4/100 L0GT5	725	1270	675
DRG 1200/4/100 H0HT5	725	1270	675
DRG 1200/4/100 L0HT5	725	1270	675
DRG 1500/4/100 A0HT5	725	1270	675
DRG 2000/4/100 A0HT5	725	1270	675
DRG 2000/4/100 B0HT5	725	1270	675
DRG 550/4/150 N0FT5	725	1270	675
DRG 750/4/150 N0FT5	725	1270	675
DRG 1000/4/150 N0GT5	725	1270	675
DRG 1200/4/150 A0HT5	725	1270	675
DRG 1200/4/150 N0HT5	725	1270	675
DRG 1500/4/150 A0HT5	725	1270	675
DRG 2000/4/150 A0HT5	725	1270	675
DRG 1200/4/200 B0HT5	725	1270	675
DRG 1500/4/200 B0HT5	725	1270	675
DRG 2000/4/200 B0HT5	725	1270	675
DRG 1200/4/250 H0HT5	825	1070	1355
DRG 1500/4/250 H0HT5	825	1070	1355
DRG 2000/4/250 H0HT5	825	1070	1355
DRG 550/6/150 F0GT5	725	1270	675
DRG 750/6/150 F0GT5	725	1270	675
DRG 1000/6/150 F0HT5	725	1270	675
DRG 1000/6/200 A0HT5	725	1270	675
DRG 1000/6/200 B0HT5	725	1270	675
DRG 1750/6/200 A0HT5	725	1270	675
DRG 1000/6/250 C0HT5	825	1070	1355
DRG 1000/6/250 H0HT5	825	1070	1355
DRG 1750/6/250 C0HT5	825	1070	1355

Погружные электронасосы электронасосы

Сферы применения

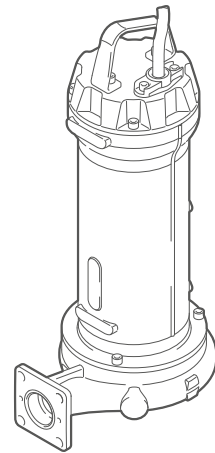
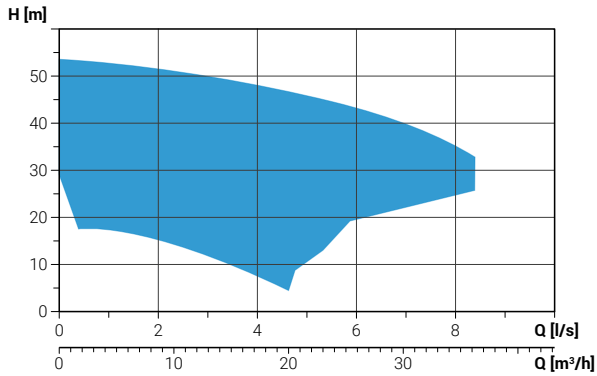

Общие характеристики

Мощность	1.8 ÷ 7.5 kW
Кол. полюсов	2
Класс изоляции	H
Коэффициент защиты	IP68
Направление вертикальный	-
Направление горизонтальный	G 1½" DN32 - G 2" DN32
Свободный просвет	-
Макс. производительность	8.4 l/s
Макс. напор	53.7 m

Доступные версии

Электрические варианты	NAE, TS
Система охлаждения	N
Механические уплотнения	2SiC

Ограничения по эксплуатации

Макс. температура эксплуатации	40 °C
РН обработанной жидкости	6 ÷ 14
Вязкость обработанной жидкости	1 mm²/s
Макс. глубина погружения	20 m
Плотность обработанной жидкости	1 Kg/dm³
Макс. акустическое давление	<70dB
Макс. запусков/час	30

Двигатель

Экологический сухой двигатель с тепловой защитой.

Кабель

Кабель S1RN8-F 10 m (стандартная версия)

Механические уплотнения

Два механических уплотнения из карбида кремния (2SiC), оба устанавливаемых в камере с маслом

Назначение оборудования

Разработанный для промышленного и профессионального применения, он пригоден для обработки жидкостей, содержащих твердые тела или волокна во взвешенном состоянии, активный шлам низкой или средней вязкости.

Материалы для изготовления

Каркас	Чугун EN-GJL 250
Гидравлическая часть	Чугун EN-GJL 250
Материал крыльчатки	Чугун EN-GJL 250
Крепеж	Нержавеющая сталь - Класс A2-70
Стандартное уплотнение	Резина - NBR
Вал	Нержавеющая сталь - AISI 431
Окраска	Эпоксидная, двухкомпонентная, на водной основе (средняя толщина ~200 мкм)
Системы измельчения	Хромистая сталь
Всасывающая решетка	-

Установка

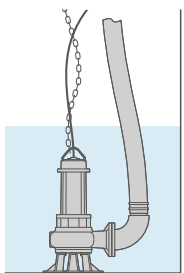

Свободная установка

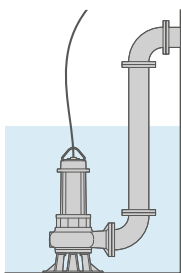

Фиксированная установка

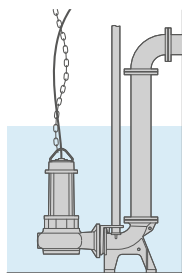

Установка с донным соединительным устройством

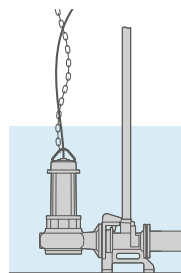



GRG 150÷250/2/G40H

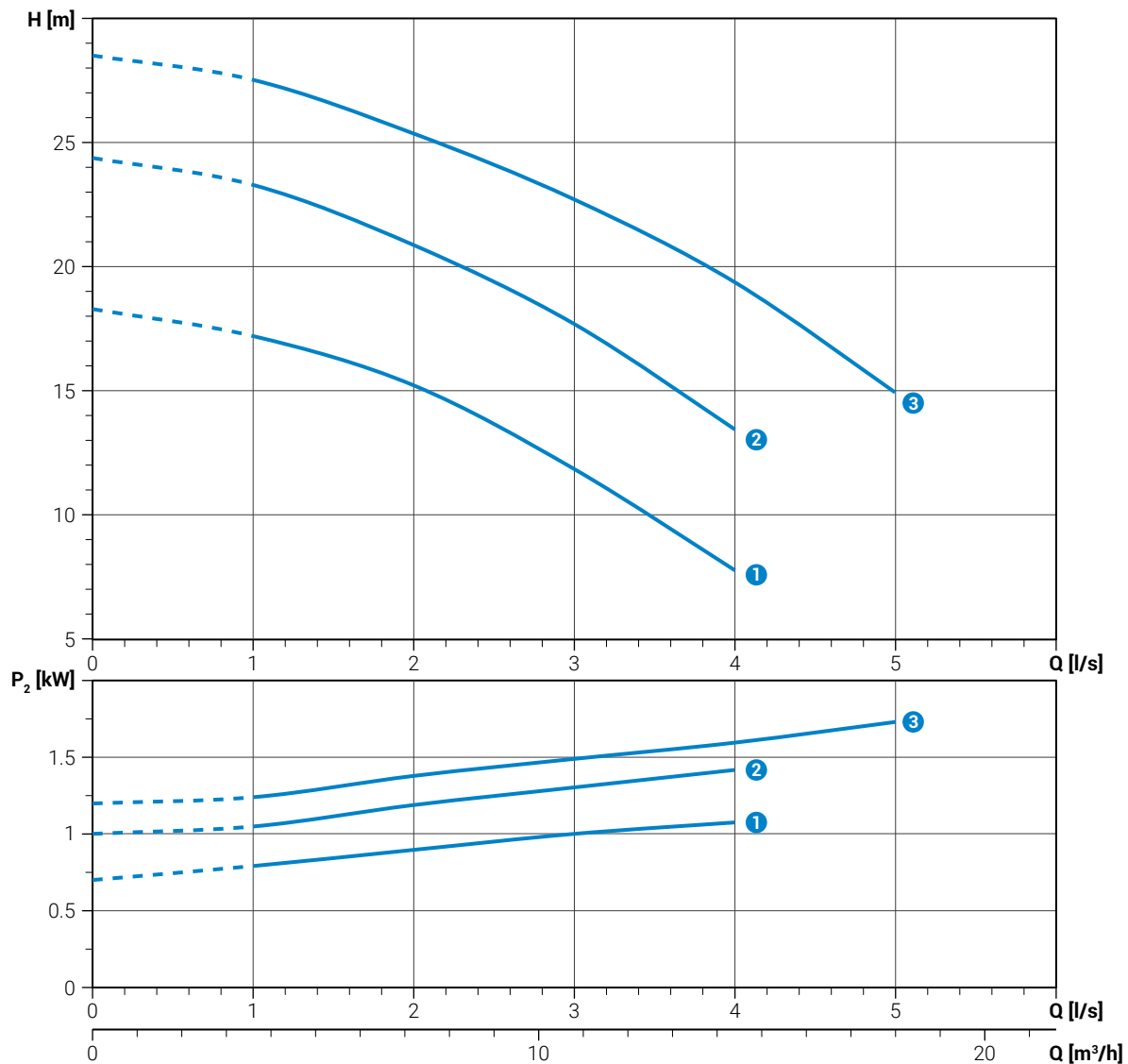

Характеристики

	l/s	0	1	2	3	4	5
	l/min	0	60	120	180	240	300
	m ³ /h	0	3.6	7.2	10.8	14.4	18
①	GRG 150/2/G40H B3AT5	18.3	17.2	15.2	11.8	7.8	
②	GRG 200/2/G40H B3AT5	24.4	23.3	20.9	17.7	13.4	
③	GRG 250/2/G40H A0AT5	28.5	27.5	25.4	22.7	19.4	14.9



Диапазоны мощности соответствуют нормативу UNI EN ISO 9906

Технические данные

	V	1~ 3~	P ₁ [kW]	P ₂ [kW]	A	Rpm	DOL Y/Δ				
①	GRG 150/2/G40H B3AT5	400	3~	1.3	1.1	2.4	2900	DOL	4G1.5+3x1	G1"½ DN32	-
②	GRG 200/2/G40H B3AT5	400	3~	1.8	1.5	3.3	2900	DOL	4G1.5+3x1	G1"½ DN32	-
③	GRG 250/2/G40H A0AT5	400	3~	2.2	1.8	3.7	2900	DOL	4G1	G1"½ DN32	-

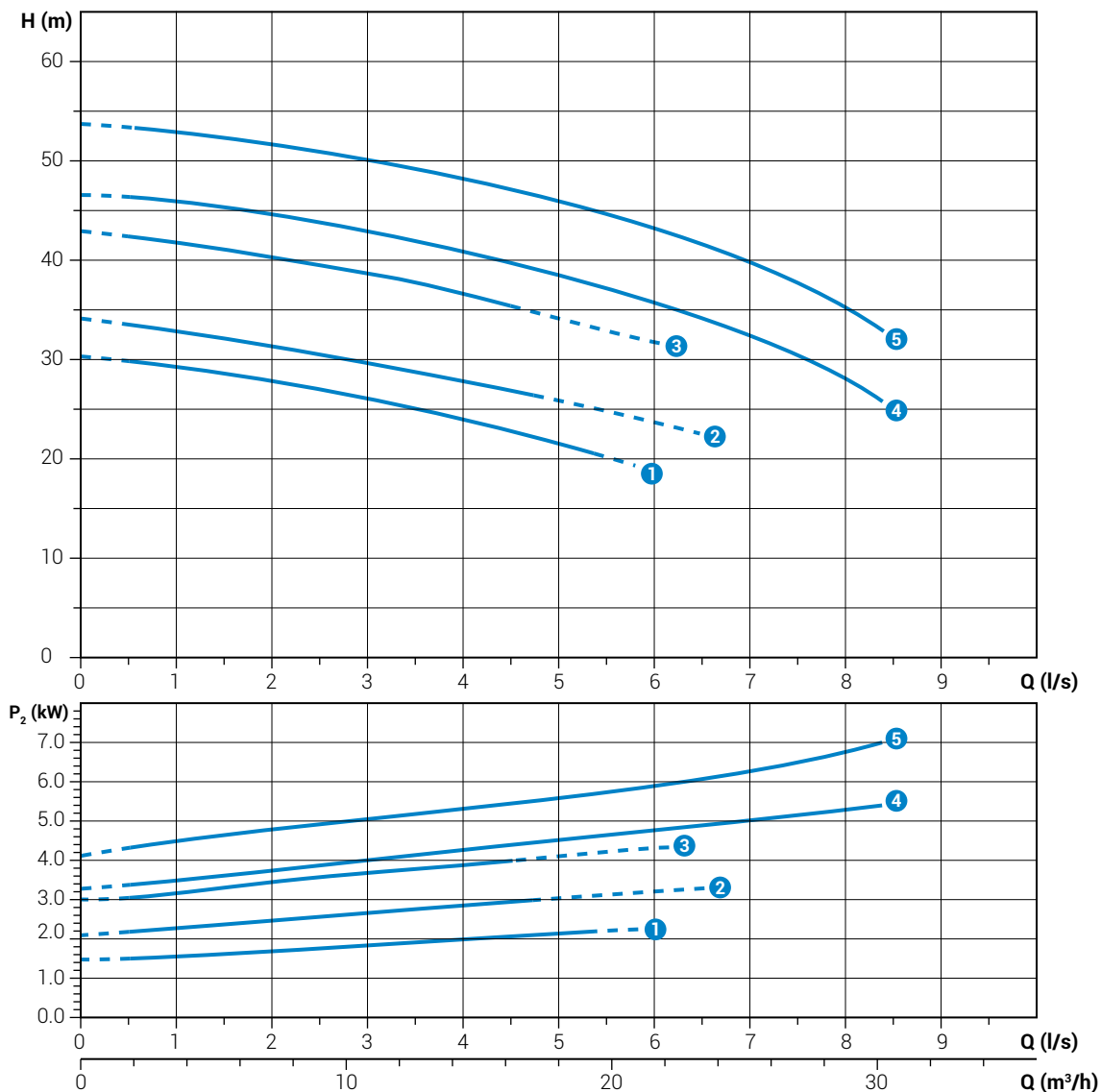

**GRG 300÷1000/2/G50H****Характеристики**

	l/s	0	1	2	3	4	5	6	7	8
	l/min	0	60	120	180	240	300	360	420	480
	m ³ /h	0	3.6	7.2	10.8	14.4	18	21.6	25.2	28.8
1	GRG 300/2/G50H C0ET5	30.3	29.3	27.9	26.1	24.0	21.6			
2	GRG 400/2/G50H D0ET5	34.2	33.0	31.5	29.8	28.0	26.0	23.9		
3	GRG 550/2/G50H D0T5	45.1	44.4	42.8	40.6	38.1	35.3			
4	GRG 750/2/G50H A0FT5	46.6	45.9	44.6	42.8	40.8	38.5	35.8	32.4	27.9
5	GRG 1000/2/G50H A0FT5	53.7	52.9	51.6	50.0	48.2	46.0	43.3	39.8	35.2



Диапазоны мощности соответствуют нормативу UNI EN ISO 9906



Технические данные

	V	1~ 3~	P ₁ [kW]	P ₂ [kW]	A	Rpm	DOL Y/Δ				
1	GRG 300/2/G50H C0ET5	400	3~	2.8	2.2	4.6	2900	DOL	4G1.5+3x1	G2" DN32	-
2	GRG 400/2/G50H D0ET5	400	3~	3.7	3.0	6.4	2900	DOL	4G1.5+3x1	G2" DN32	-
3	GRG 550/2/G50H D0T5	400	3~	4.7	4.0	7.7	2900	DOL	4G1.5+3x1	G2" DN32	-
4	GRG 750/2/G50H A0FT5	400	3~	6.3	5.5	10.8	2900	DOL	4G1.5+3x1	G2" DN32	-
5	GRG 1000/2/G50H A0FT5	400	3~	8.5	7.5	13.7	2900	DOL	4G1.5+3x1	G2" DN32	-

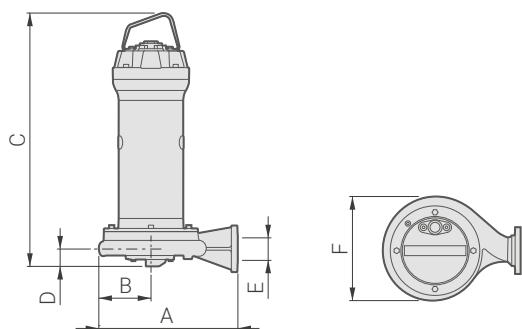

GRG



	A	B	C	D	E	F		
GRG 150/2/G40H B3AT5	267	107	500	29	G1"½	215	DN32 PN6	31.5
GRG 200/2/G40H B3AT5	267	107	500	29	G1"½	215	DN32 PN6	32.0
GRG 250/2/G40H A0AT5	267	103	491	45	G1"½	215	DN32 PN6	32.0
GRG 300/2/G50H C0ET5	305	110	527	56	G2"	225	DN32 PN6	43.2
GRG 400/2/G50H D0ET5	352	132	594	59	G2"	263	DN32 PN6	45.0
GRG 550/2/G50H D0T5	352	128	652	59	G2"	263	DN32 PN6	57.6
GRG 750/2/G50H A0FT5	352	128	652	59	G2"	263	DN32 PN6	60.3
GRG 1000/2/G50H A0FT5	352	128	727	59	G2"	263	DN32 PN6	68.2



	X	Y	Z
GRG 150/2/G40H B3AT5	310	580	310
GRG 200/2/G40H B3AT5	310	580	310
GRG 250/2/G40H A0AT5	310	580	310
GRG 300/2/G50H C0ET5	445	725	425
GRG 400/2/G50H D0ET5	445	725	425
GRG 550/2/G50H D0T5	445	725	425
GRG 750/2/G50H A0FT5	445	725	425
GRG 1000/2/G50H A0FT5	535	915	560

Погружные электронасосы с крыльчаткой высокого напора

Сферы применения

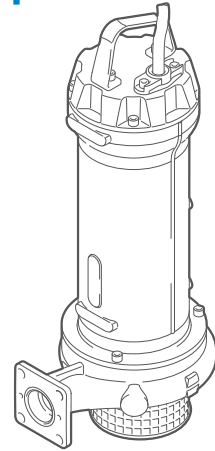
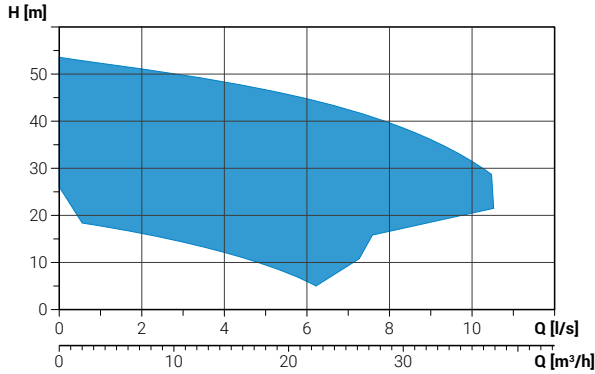

Общие характеристики

Мощность	1.8 ÷ 7.5 kW
Кол. полюсов	2
Класс изоляции	H
Коэффициент защиты	IP68
Направление вертикальный	-
Направление горизонтальный	G1 ½" DN32 - G2" DN32
Свободный просвет	max 10 mm
Макс. производительность	10.5 l/s
Макс. напор	52.0 m

Доступные версии

Электрические варианты	NAE, TS
Система охлаждения	N
Механические уплотнения	2SiC

Ограничения по эксплуатации

Макс. температура эксплуатации	40 °C
РН обработанной жидкости	6 ÷ 14
Вязкость обработанной жидкости	1 mm²/s
Макс. глубина погружения	20 m
Плотность обработанной жидкости	1 Kg/dm³
Макс. акустическое давление	<70dB
Макс. запусков/час	30

Двигатель

Экологический сухой двигатель с тепловой защитой.

Кабель

Кабель S1RN8-F 10 m (стандартная версия)

Механические уплотнения

Два механических уплотнения из карбида кремния (2SiC), оба устанавливаемых в камере с маслом

Назначение оборудования

Рекомендуется для чистой, атмосферной воды, дренажной воды. Значительный манометрический напор обеспечивает отличные результаты при устройстве водных игр и декоративных фонтанов, пригоден для использования в сельском хозяйстве, поливе и рыбоводстве.

Материалы для изготовления

Каркас	Чугун EN-GJL 250
Гидравлическая часть	Чугун EN-GJL 250
Материал крыльчатки	Чугун EN-GJL 250
Крепеж	Нержавеющая сталь - Класс A2-70
Стандартное уплотнение	Резина - NBR
Вал	Нержавеющая сталь - AISI 431
Окраска	Эпоксидная, двухкомпонентная, на водной основе (средняя толщина ~200 мкм)
Системы измельчения	-
Всасывающая решетка	Нержавеющая сталь - AISI 304

Установка

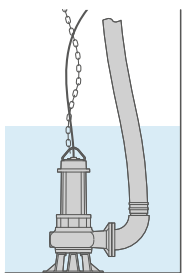

Свободная установка

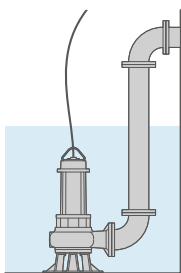

Фиксированная установка

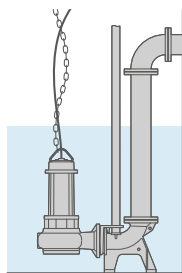

Установка с донным соединительным устройством

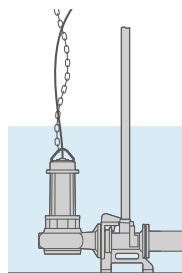



APG 150÷250/2/G40H

Характеристики

	l/s	0	1	2	3	4	5	6	7
	l/min	0	60	120	180	240	300	360	420
	m ³ /h	0	3.6	7.2	10.8	14.4	18	21.6	25.2
①	APG 150/2/G40H B3AT5	18.2	17.5	15.7	14.3	12.3	9.5	5.7	
②	APG 200/2/G40H B3AT5	23.0	21.8	20.3	18.8	16.9	14.3	10.6	
③	APG 250/2/G40H A0AT5	25.9	25.7	24.6	23.3	21.6	19.2	16.2	12.3

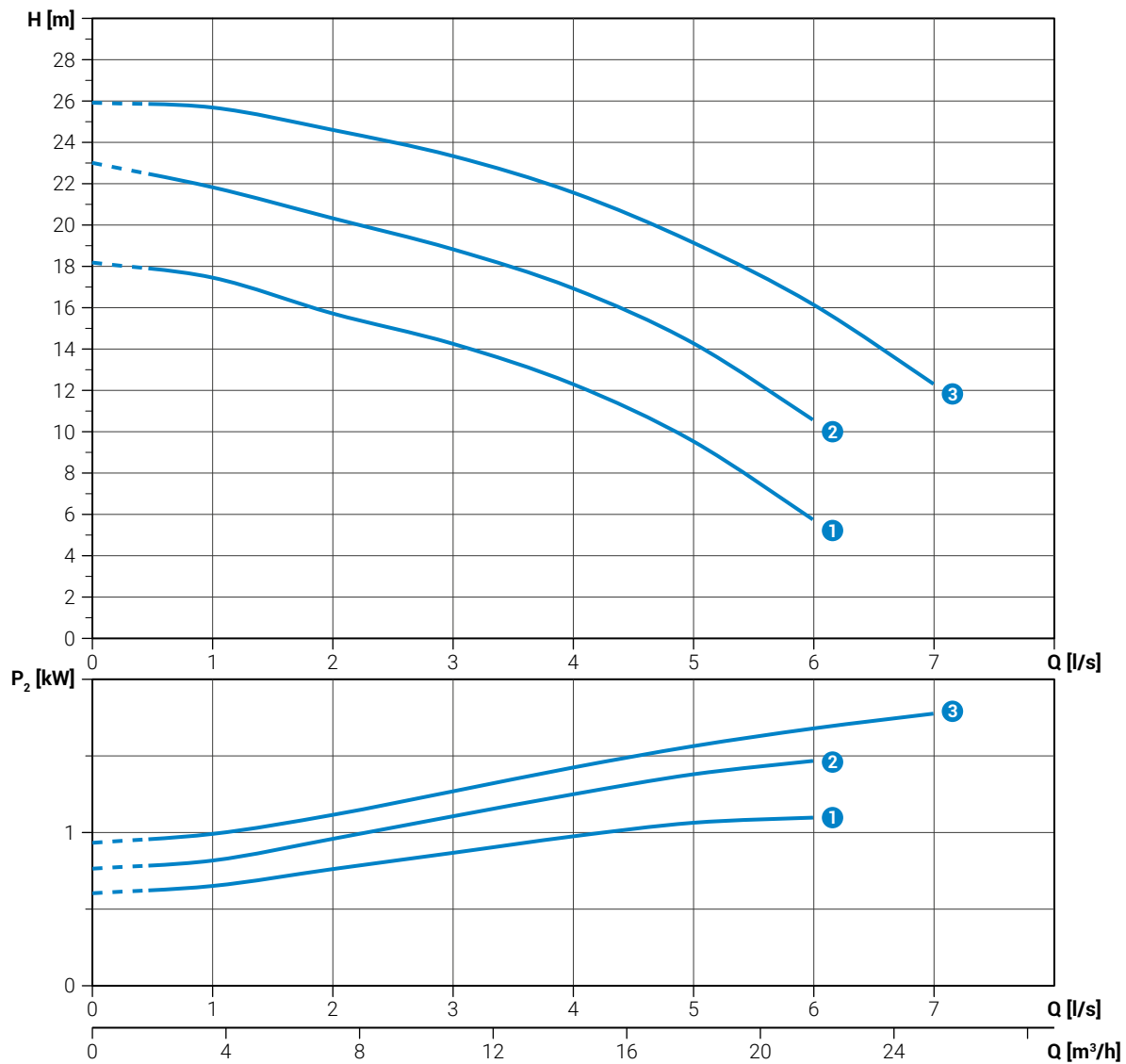

Диапазоны мощности соответствуют нормативу UNI EN ISO 9906

Технические данные

	V	1~ 3~	P ₁ [kW]	P ₂ [kW]	A	Rpm	DOL Y/Δ				
①	APG 150/2/G40H B3AT5	400	3~	1.3	1.1	2.4	2900	DOL	4G1.5+3x1	G1"½ DN32	7 mm
②	APG 200/2/G40H B3AT5	400	3~	1.8	1.5	3.2	2900	DOL	4G1.5+3x1	G1"½ DN32	7 mm
③	APG 250/2/G40H A0AT5	400	3~	2.2	1.8	3.7	2900	DOL	4G1	G1"½ DN32	10 mm

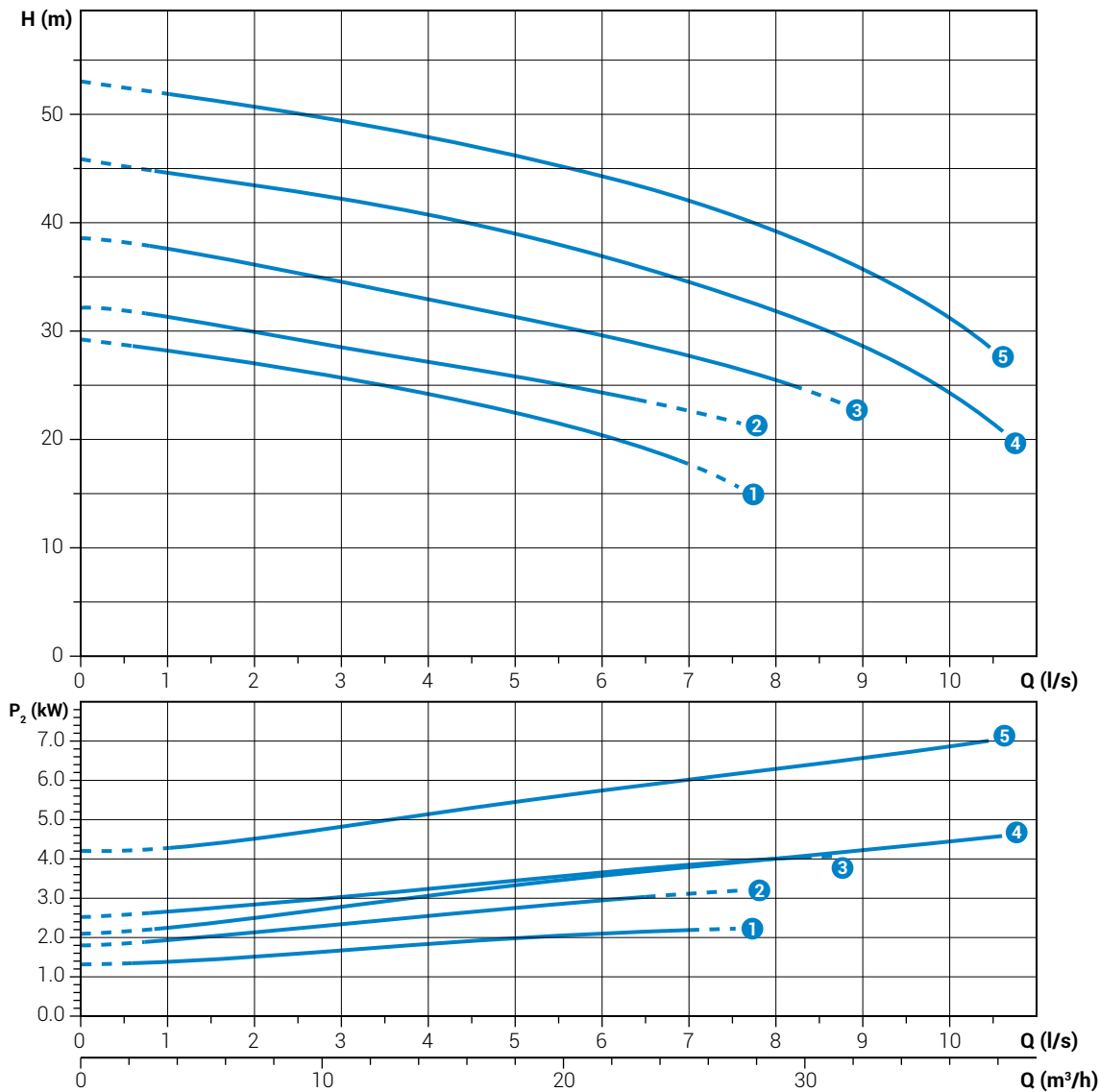

**APG 300÷1000/2/G50H****Характеристики**

	l/s	0	1	2	3	4	5	6	7	8	9	10
	l/min	0	60	120	180	240	300	360	420	480	540	600
	m ³ /h	0	3.6	7.2	10.8	14.4	18	21.6	25.2	28.8	32.4	36
1	APG 300/2/G50H C0ET5	29.2	28.2	27.0	25.6	24.1	22.5	20.4	17.6			
2	APG 400/2/G50H D0ET5	32.2	31.4	29.9	28.5	27.2	25.9	24.4				
3	APG 550/2/G50H D0FT5	38.6	37.6	36.1	34.5	32.9	31.3	29.6	27.7	25.4		
4	APG 750/2/G50H A0FT5	45.8	44.5	43.5	42.2	40.7	38.9	36.8	34.5	31.8	28.6	24.2
5	APG 1000/2/G50H A0FT5	53.0	51.8	50.7	49.4	48.0	46.3	44.3	42.0	39.2	35.8	31.2



Диапазоны мощности соответствуют нормативу UNI EN ISO 9906



Технические данные

	V	1~ 3~	P ₁ [kW]	P ₂ [kW]	A	Rpm	DOL Y/Δ				
1	APG 300/2/G50H C0ET5	400	3~	2.8	2.2	4.6	2900	DOL	4G1.5+3x1	G2" DN32	8 mm
2	APG 400/2/G50H D0ET5	400	3~	3.7	3.0	6.4	2900	DOL	4G1.5+3x1	G2" DN32	8 mm
3	APG 550/2/G50H D0FT5	400	3~	4.7	4.0	7.7	2900	DOL	4G1.5+3x1	G2" DN32	8 mm
4	APG 750/2/G50H A0FT5	400	3~	6.3	5.5	10.8	2900	DOL	4G1.5+3x1	G2" DN32	10 mm
5	APG 1000/2/G50H A0FT5	400	3~	8.5	7.5	13.7	2900	DOL	4G1.5+3x1	G2" DN32	10 mm

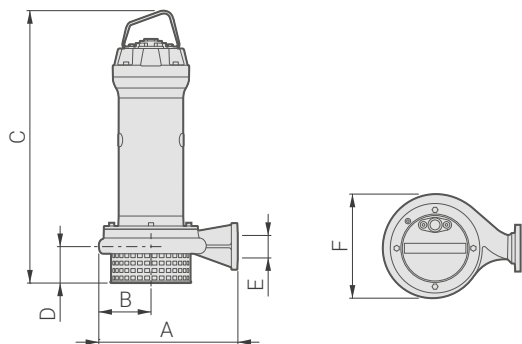

APG



	A	B	C	D	E	F		
APG 150/2/G40H B3AT5	267	107	525	78	G1"½	215	DN32 PN6	31.5
APG 200/2/G40H B3AT5	267	107	525	78	G1"½	215	DN32 PN6	32.0
APG 250/2/G40H A0AT5	267	107	523	78	G1"½	215	DN32 PN6	32.0
APG 300/2/G50H C0ET5	305	110	550	79	G2"	225	DN32 PN6	43.2
APG 400/2/G50H D0ET5	352	132	613	76	G2"	263	DN32 PN6	46.0
APG 550/2/G50H D0FT5	352	132	670	76	G2"	263	DN32 PN6	57.6
APG 750/2/G50H A0FT5	352	128	669	76	G2"	263	DN32 PN6	60.3
APG 1000/2/G50H A0FT5	352	128	744	76	G2"	263	DN32 PN6	68.2



	X	Y	Z
APG 150/2/G40H B3AT5	310	580	310
APG 200/2/G40H B3AT5	310	580	310
APG 250/2/G40H A0AT5	310	580	310
APG 300/2/G50H C0ET5	445	725	425
APG 400/2/G50H D0ET5	445	725	425
APG 550/2/G50H D0FT5	445	725	425
APG 750/2/G50H A0FT5	445	725	425
APG 1000/2/G50H A0FT5	535	915	560



better together